



HEAT PUMP

for swimming pool water heating & cooling

Installation and user manual



Version: 01/2021 (last update: 2021-14-06)

CC1032

HP 2300 COMPACT INVENTOR

&

HP 2800 COMPACT INVENTOR





Thank you for purchasing Microwell swimming pool heat pump. Before you use this device, it is necessary to carefully read the entire Installation and user manual. It is not allowed to commence the heat pump installation or operation unless full content of this Installation and user manual is understood and acknowledged. Please keep the Installation and user manual available in the case of any future reference is required. Please provide this information also to each user of the device. Please mind local regulations in your country regarding installation and usage of this heat pump which are valid in

addition to this User manual.

Contents

1. INTRODUCTION	4
1.1 Product description	4
1.2 Package checking.....	5
1.3 Waste disposal information	5
2. SAFETY MEASURES	6
2.1 Electrical safety.....	6
2.2 Usage precautions.....	6
2.3 Handling precautions	7
3. TECHNICAL SPECIFICATION	8
3.1 Technical data.....	8
3.2 Swimming pool water parameters.....	8
3.3 Heat pump dimensions	9
3.4 Description of the basic parts.....	9
3.5 Security and control systems	10
3.6 Block wiring diagram of the PCB board.....	11
3.7 Block wiring diagram legend	12
3.8 Sensors position	13
4. HEAT PUMP INSTALLATION AND CONNECTION.....	14
4.1 Positioning.....	14
4.2 Connection to water filtration circuit.....	15
4.3 Needed components for connection to water circuit.....	16
4.4 Electrical connection	18
4.5 Multiple heat pump connection.....	18
4.6 Seaside installation.....	19
4.7 Control of the circulation pump	20
4.8 Separate water circuit	21

4.9	Circulation pump connection	21
5.	REGULATION.....	22
5.1	Description of the LCD panel.....	22
5.2	General heat pump control	23
5.3	Heat pump operational modes	24
5.4	Clock	24
5.5	Timer	25
5.6	Child lock	26
5.7	Parameters check	26
5.8	Setting of the operating parameters.....	27
5.9	Remote display placement and WIFI.....	29
5.10	Phase monitor specification	29
6.	ACCESSORIES	31
6.1	Winter module	31
6.2	Heat exchanger frost protection	31
6.3	Condensate tray defrost.....	32
6.4	Protection cover	32
7.	HINTS AND TIPS	32
7.1	Water condensation.....	32
7.2	Defrosting	33
7.3	On-Off Contact	33
7.4	Winterizing	33
7.5	Heat pump season start	34
7.6	Pool cooling at tropical conditions.....	35
5.1	Failure reports	36
5.2	Troubleshooting – save time and money.....	38
8.	MAINTANANCE & WARRANTY	39
8.1	Maintanance.....	39
8.2	Warranty.....	40

1. INTRODUCTION

In your hands you hold probably the most advanced and the most efficient heat pump currently available on the market. This heat pump provides warm water in your pool at lowest possible cost. The heat pump is manufactured in tightest accordance with related strict standards and norms, in order to provide high quality operation and long-term reliability.

This Installation and user manual contains all the necessary information about the installation, operation and maintenance of the heat pump. Please read this Installation and user manual carefully before you start to use this product. The manufacturer is not responsible for any personal or property damage due to the improper installation, use or maintenance that is not in accordance with this User Manual.

This Installation and user manual is an inseparable part of this product; therefore it must be kept in good condition and must accompany the heat pump.

1.1 Product description

The heat pump is designed exclusively for swimming pool water heating or cooling and maintaining its temperature on the requested level. Other appropriate application is water temperature conditioning for fish tanks, wine ciders or horse cooling facilities. These applications should be discussed with local installer or distributor. Any other form of application is considered inappropriate.

The heat pump achieves the highest efficiency at 15÷35°C air temperature. At ambient air temperatures lower than -5°C the efficiency of the device decreases and at the temperatures higher than +40°C the heat pump can get overheated which may result in its malfunction, damage or failure. Do not use the product out of the designated operational air temperature range which is stated *in section 3.1 Technical data*.

This heat pump is designed for swimming pools with up to 80 m³ - HP 2300 and up to 120 m³ - HP 2800 of pool water volume. For proper operations there must be water flow through the exchanger of the heat pump (within water filtration circuit) in the range of 8-12 m³/h.

The heat pump enables heat gain from the external air surrounding the swimming pool through the compression – expansion cycles of the heat-carrying liquid. The air is driven by a fan through the evaporator where it will deliver its heat to the heat-carrying liquid (the air is being cooled at the same time). The heat-carrying liquid is then delivered to the spirals of the exchanger by the compressor which pressurises it and thus heats it up. In these spirals, the heat-carrying liquid delivers its heat to the swimming pool water. From the exchanger there is a cooled liquid flowing to the expansion valve or capillary where its pressure decreases and it gets cooled down rapidly at the same time. This cooled liquid flows to the evaporator again where it gets heated by the flowing air. The whole process runs fully automatically and is monitored by the pressure and temperature sensors. The same principle is applied when heat pump operates in cooling mode.

Using simple language, a heat pump is able to extract the heat/cold that is present in ambient environment and leveraged pass it into the pool water. When heating, higher the ambient air temperature is, more free energy can the heat pump extract and thus reach higher efficiency. At favourable conditions you pay around 15% of heat, i.e. 85% of heat is free. Please review below drawing of different ambient air conditions with subsequent efficiencies.

The heat pump efficiency grows by the increasing surrounding air temperature.

It takes some days to achieve the requested swimming pool water temperature. This time period depends on heat loss and heat gain balance of your pool.

Example factors of heat losses: poor pool construction, used materials, usage of cover, air – water temperature relationship, fresh water refilling, filtration, etc.

Example factors of heat gains: intensity of sun, winds, orientation of pool, air – water temperature relationship, etc.

In order to avoid heat loss when the swimming pool is not being used, it is highly advised to use pool's cover.

Ideal water temperature for external pools is considered at levels from 27° to 32°C. This may change based on particular demands of the user. When setting the desired air temperature higher than 32°C please review the material characteristics of your pool parts. High water temperature can damage these materials and contribute to creation of algae. Manufacturer, distributor and reseller do not bear responsibility resulting from inappropriate heat pump usage.

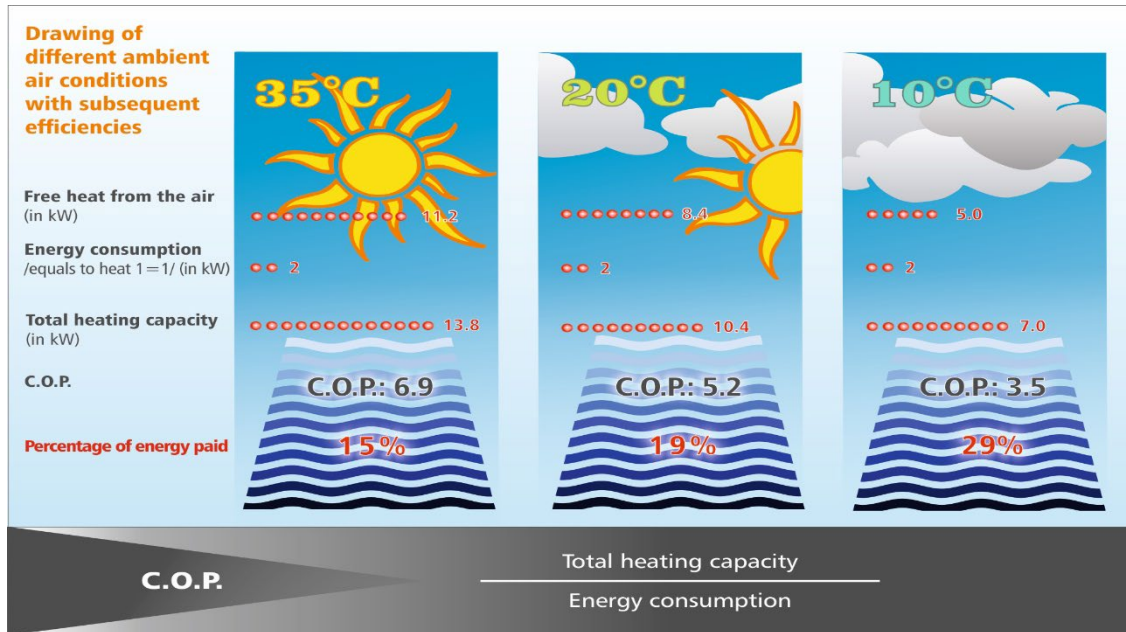

1.2 Package checking

The unit was delivered in carton box on a wooden palette. Do not accept the package if it shows signs of damage. If the package appears intact, please unpack the unit and check the content. It should include the following:

1. The heat pump – one compact piece. Please check *section 3.4 Description of the basic parts* to see how the heat pump looks like
2. This Installation and user manual
3. Four rubber silent blocks

1.3 Waste disposal information

When using this heat pump in the European countries, the following information must be followed:

DISPOSAL: Do not dispose this product as unsorted municipal waste. It is prohibited to dispose this heat pump in domestic / household waste. It is prohibited to dispose this appliance into forests or natural landscape. This could lead into local soil pollution. Collection of such waste must be treated individually.



DISPOSAL POSSIBILITIES:

1. The municipality has established a collection system where electronic waste can be disposed.
2. When buying a new product, the retailer or the manufacturer may take back the old appliance free of charge.
3. Old appliance may contain valuable resources which could be sold to scrap material dealers.
4. Disposal of packaging materials such as carton box or plastic / bubble foil can be recycled.



2. SAFETY MEASURES

It is necessary to follow instructions in this Installation and user manual and local regulations in your country that regulate the installation and usage of this device. Incorrect, improper or operations contradictory to this Installation and user manual may lead to an injury or property damage and will lead to loss of warranty. To prevent injury or property damage the following instructions must be followed:

2.1 Electrical safety



- *The device operates at dangerous electrical current.*
- *Only authorized person with particular electro-technical qualification can manipulate with unit.*
- *Danger of electrical shock.*
- *Do not exceed the required power supply.*
- *Do not turn the device on that shows signs of possible damage such as broken packaging, broken or otherwise damaged unit's chassis or cover, smoke, smell, etc.*
- *It is necessary to use appropriate Residual current circuit breaker (RCD) for connection of the heat pump to main power supply.*
- *Do not manipulate with the device with wet hands.*
- *Do not clean the device with water.*
- *Before cleaning the device, switch off the circuit breaker of the unit's power supply.*
- *Installation, service or repair must be performed by qualified technician.*
- *When the device is not intended to be used for a longer time, we recommend switching the circuit breaker of the unit's power supply off.*
- *Unit must be installed in vertical position to avoid condensate water to enter electrical part of the unit.*
- *It is forbidden to install the unit close to devices that may cause electrical or frequency disturbance such as welding machines, motors or rotors, WIFI/WLAN routers or repeaters.*
- *It is forbidden to alter electrical installation of the device. It is also forbidden to alter any other part or functionality of the device.*

2.2 Usage precautions



Do not cover or block the intake or exhaust opening / ventilator and evaporator covers. It is forbidden to block or cover the intake or exhaust openings with clothes, towels, buckets, canoes, trees, etc. Such action would lead to a decrease of needed airflow. That would result in heat pump inefficiency and underperformance, eventually to heat pump overeat with subsequent security turning off, malfunction, failure or damage. Especially during bloom months it is highly advised to keep the evaporator fins clean.

- *Do not climb up on or sit on the unit.*
- *Do not place any objects on the top of the unit (e.g. boxes, flower vases, etc.).*
- *Do not spray any flammable substances into the equipment; this might lead to fire.*
- *Do not clean the equipment with aggressive cleaning agents, this might lead to damage or deformations.*
- *When cleaning plastic parts do not use any cleaning agents unsuitable for plastic (household cleaning agents, solvents, bleaching agents, benzene, diluents, rough cleaning powder, cresol, chemical agents). Instead, sweep the heat pump cover with a soft cloth or a sponge.*
- *Never throw or insert any objects into any hose or opening.*
- *The cover is made of metal. Do not manipulate with lighted cigarette, cigarette ashes, or any other kind of fire in vicinity to this part.*
- *Use this device exclusively for the intended purpose, as described in the attached instruction manual. Do not use parts which are not recommended.*
- *Never block the air opening of the product. Protect the air openings from clogging by particles.*
- *Do not drink or use the condensate water drained from the unit. Do not return the water back to the*

swimming pool. The water may be contaminated with bacteria.

- *Children are not allowed to operate, touch or play with the unit.*
- **Children are not allowed to manipulate with packaging, plastic / bubble foil. Risk of suffocation!**
- *Prevent the children from injury or harm caused by any manipulation with the unit, its parts or its packaging. Small parts like screws may be swallowed and cause harm to health.*
- *Do not leave the children in the swimming pool / at the swimming pool unattended.*
- *The positioning of the heat pump must be in accordance with the STN 33 2300-7-702 standard, i.e. it must be placed at least 3,5 m from the swimming pool's external border.*
- *For heating/cooling the swimming pool by the heat pump, the filtration pump must run and the water must flow through the heat exchanger.*
- *Never turn on the heat pump if it is without water and if the filtration device is not operating.*
- *Protect the heat pump from freezing. Eliminate the water from the filtration and from the heat pump's water heat exchanger and prepare the product for the winter time.*
- *At low surrounding ambient temperature level (below 10°C) and high relative air humidity level (e.g. after rain, during the night, etc.), the evaporator may get iced up. Heat pump will automatically defreeze itself. Its operations or functionality is not harmed but the efficiency decreases.*
- *Manufacturer does not bear any responsibility concerning damages caused by inappropriate heat pump performance and/or model selection, installation or application. Heat pump is considered undersized in the case it works usually and in long-term more than 18 hours daily. General warranty void applies for damages on the device or other damages if the device works usually in long-term more than 18 hours daily.*
- *The heat pump must be correctly sized for its application.*
- *Do not pressurize the water heat exchanger higher than 0.5MPa (5bar). By pressure of 0.8MPa (8bar) the water heat exchanger gets irreversibly damaged. It is advised to install a security valve with pressure threshold at 0.5MPa (5Bar) before the heat exchanger.*
- *Do not apply or use water of higher temperature than 60°C in water heat exchanger. Water temperature above 60°C irreversibly damages the water heat exchanger.*

2.3 Handling precautions

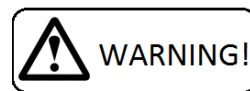

- *Leave the unit in vertical upright position for at least 2 hours before the installation.*
- *Transport in lying position or turning the device over may harm the compressor resulting in unit's malfunction, failure or damage and will lead to loss of warranty.*
- *The device must be handled with care and special attention avoiding any mechanical damage.*
- *It is forbidden to apply any improper mechanical force onto the unit. This may cause mechanical damage to the device.*
- *It is forbidden to let the device fall freely onto the ground or any solid surface resulting in hard impact.*
- *Please notify your reseller or distributor if you suspect that the unit was delivered damaged. Unit may seem to work well at start but small damage can make the unit go out-of-order in short time. In such case the unit must be inspected and approved for further use by your reseller.*
- *Please notify your reseller or distributor if directly after installation you suspect that unit is not working in perfect order.*
- *In the case of device failure resulting from improper handling or mechanical damage (impact, hit, fall, etc.), the manufacturer reserves the right to evaluate the continuity of warranty.*

3. TECHNICAL SPECIFICATION

3.1 Technical data

	HP 2300 INVENTOR		HP 2800 INVENTOR	
	25°C/10°C	25°C/20°C	25°C/10°C	25°C/20°C
Air temperature/water temperature	25°C/10°C	25°C/20°C	25°C/10°C	25°C/20°C
Heating output (kW)	20.01	18.89	26.01	24.55
Power consumption (kW)	3.01	3.10	4.00	4.02
Coefficient of Performance (C.O.P.)	6.5	6.1	6.5	6.1
Recommended swimming pool volume (m ³) (with a cover/without a cover)	80/60		120/80	
Energy class	A		A	
Operating temperature – air (°C)	-5(-15)** +40		-5(-15)** +40	
Optional swimming pool water temperature range (°C)	+5+40		+5+40	
Air flow (m ³ /h)	5040		5040	
Recommended water flow (m ³ /h)/pressure loss (kPa)	8-10/5-15		8-12/5-15	
Feeding voltage/Protection (V/A)	400 / 20/1C		400 / 20/1C	
Current-carrying capacity/max. current (A)	6.5/10		9/14	
Coverage/Protection	IP X4/by grounding		IP X4/by grounding	
Heat exchanger	Titanium		Titanium	
Acoustic pressure level dB (A) 1m/2m/4m/8m	56/50/44/38		56/50/44/38	
Water circuit connection (mm/inch, thread)	50/ 6/4" internal		50/ 6/4" internal	
Max. recommended water pipe length (m)	30		30	
Max. operational water pressure	0.15MPa (1.5bar)		0.15MPa (1.5bar)	
Net unit dimensions (w/h/d)	942/1550/360		942/1550/360	
Gross unit dimensions (w/h/d)	1090/1760/465		1090/1760/465	
Net/Gross weight (kg)	118/122		120/124	
Refrigerant/filling weight (type/kg)	R410A/2.8; 5.85t CO2 ekv.		R410A/3.00; 6.26t CO2 ekv.	

* The manufacturer reserves the right to change the parameters without notice.

** In the case Winter module, condensate tray antifreeze or heat exchanger frost protection is installed.

The refrigerant circuit is filled with R410A refrigerant that consists of 2 components (R32/R125). These components are considered as fluorocarbon greenhouse gases. The product contains fluorocarbon greenhouse gases listed in the Kyoto Protocol:

R410A with the global warning potential (GWP) 1720 (R-32/125 50/50) CH₂F₂ + CF₃CHF₂.



Based on EU regulation 842/2006 there is an obligation to perform a refrigerant revision on your heat pump once a year. Please contact your distributor, reseller or installer.



3.2 Swimming pool water parameters

The heat pump is designed for heating the swimming pool water. Although the water heat exchanger is made from the most durable titanium, in order to ensure long term reliability of the heat pump the pool water must be in accordance with the related sanitary requirements.

The limit values for the heat pump operation are the following:

- pH value ranging from 6.8 to 7.9,
- total chlorine amount not exceeding 3 mg/l,
- salt content 6% wt/wt.

Should you have different values of pH, chlorine or salt please try to apply appropriate agents or contact your swimming pool builder to resolve the situation. Above mentioned values are recommended for pools in general.

It is also advised to keep the water hardness on the lower limit of the optimal range, i.e. closely above 8 °N.

3.3 Heat pump dimensions

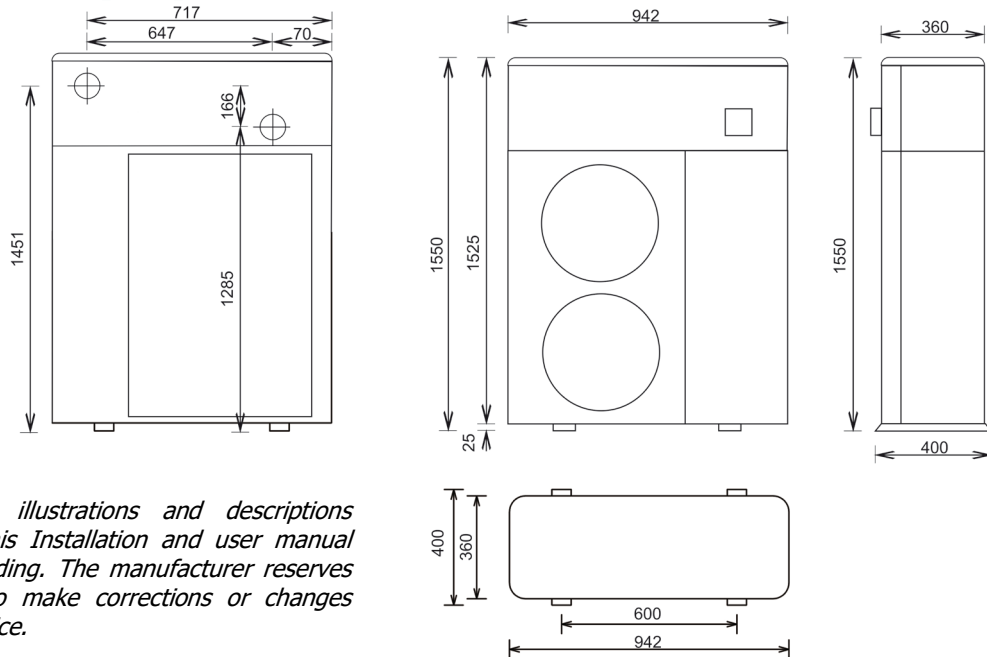

Note: The illustrations and descriptions found in this Installation and user manual are not binding. The manufacturer reserves the right to make corrections or changes without notice.

3.4 Description of the basic parts

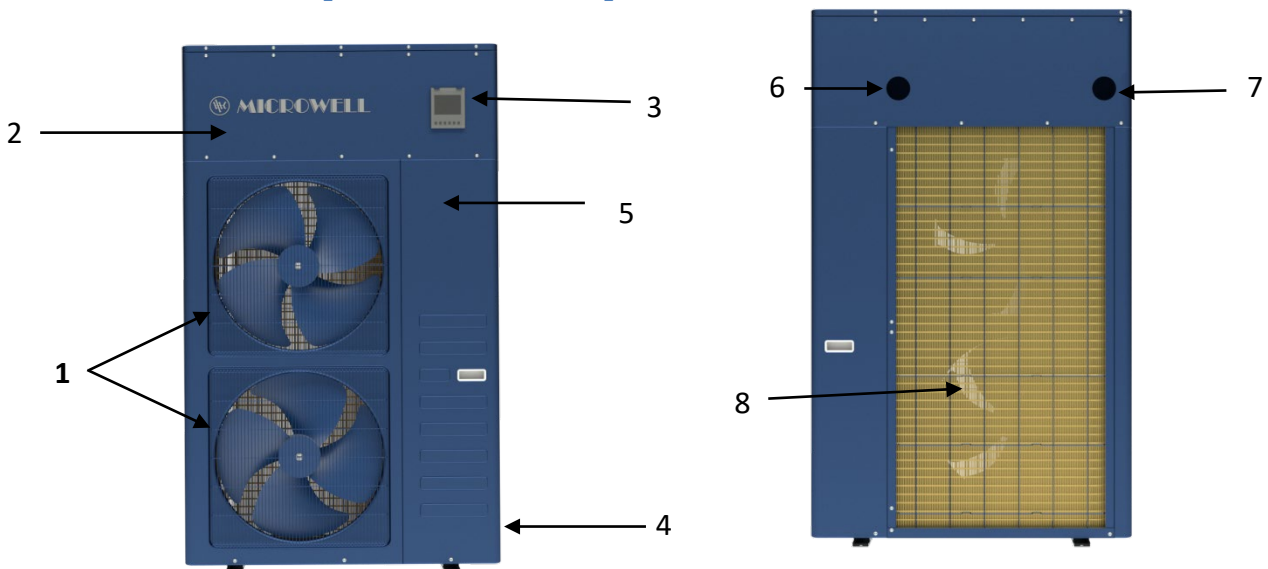

- Legend:**
- 1** – Protecting grates of the fan (air outlet) / ventilator cover
 - 2** – Cover / metal chassis
 - 3** – Control panel
 - 4** – Valve for refilling the refrigerant (under the cover)
 - 5** – Power supply connection (underneath the cover)
 - 6** – Water outlet connection hub
 - 7** – Water inlet connection hub
 - 8** – Evaporator (air inlet)

3.5 Security and control systems

In order to ensure long term reliability and fully automatic operations of the heat pump, the pump is equipped with following security systems:

Temperature based control of the heat pump operation:

- The heat sensor placed on the heat exchanger, ensures switching off of the heat pump when the requested water temperature is reached. The normal operating mode gets renewed if the water temperature in the exchanger drops by 3 °C (manufacturing setting) below the requested value.

Safety systems:

- Water flow sensor (flow switch) placed on the water heat exchanger inlet. The water flow sensor switches on the heat pump when there is water flowing through the heat pump exchanger, and switches it off when the water flow stops or is too high or low.
- Sensor of the minimal and maximal gas pressure in the refrigerant circuit.
- Heat sensor on the refrigerant outlet from the compressor.

Time protection

- The unit is equipped with a switching time delaying device with a preset 3 minutes delay period for protecting the control elements in the circuit and eliminating repeated restarts and contactor vibrations. This time delay will automatically restart the unit app. 3 minutes after every single interruption of the heat pump operation. Even if there is only a short interruption of the power supply, the time protection will get activated so the unit cannot start the operation earlier than the pressures in the refrigerant circuit of the heat pump get balanced. Interruption of the power supply during the pause time does not influence the time interval.

Antifreeze protection

- If an ambient air temperature is low (e.g. below 7°C), it is normal to have ice creations on the evaporator of your heat pump. This is freezing condensated water. Your heat pump is equipped with automatic defrosting.
- Manufacturer has preset the conditions when automatic defrosting gets activated in order to ensure optimal operations and performance of the heat pump. For more information please refer to *section 5.8 Setting of the operating parameters* and *section 7.2 Defrosting*.
- If your heat pump freezes up on often basis it is advised to reconsider the efficiency of heat pump running (heating) in such conditions.

If a failure occurs to any of above systems there will be an error message shown on the display starting with 'EE'. Please check *section 5.1 Failure reports* of this Installation and user manual.

Warning: *Elimination or disabling from operation any of the control or security systems results in warranty void.*

3.6 Block wiring diagram of the PCB board

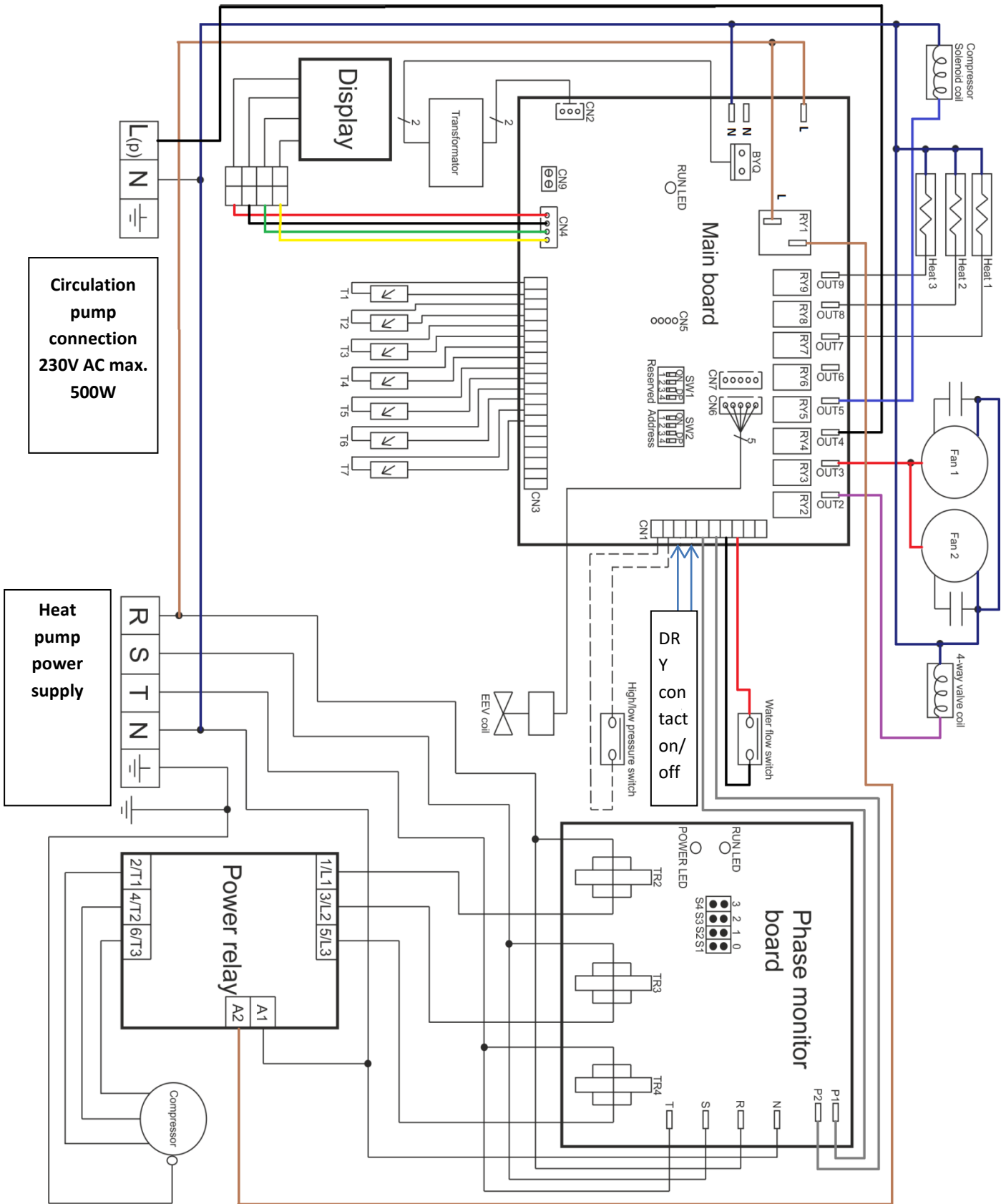

Notice: Manufacturer reserves the right to change electrical wiring without notice.

3.7 Block wiring diagram legend

T1 – Evaporator temperature / defrost sensor

T2 – Inlet water temperature

T3 – Ambient air temperature

T4 – Discharge temperature

T5 – Outlet water temperature

T6 – Suction temperature

T7 – Water heat exchanger pipe temperature

OUT1 – Compressor (RY1)

OUT2 – 4-way valve

OUT3 – Fan

OUT4 – Circulation pump

OUT5 – Compressor body solenoid valve

OUT6 – Heat pump cleaning

OUT7 - Heat 1- Heating element of heat exchanger

OUT8 - Heat 2 – Heating element of compressor body

OUT9 - Heat 3 – Heating element of condensate tray

L(h)N – connection of heat exchanger heating spiral

L(P)N G –connection of circulation pump control, max. 2.2A, max. 500W

A B C D – connection of display

1 2 3 4 5 - connection of water exchanger sensors (alterantive 1234) with T7 inside the unit

R S T N Ground – main power supply

Dry contact On/off – contact only, **no voltage, no current!**

Sensor specification

T1 – Evaporator temperature	5kohm	Copper head
T2 – Inlet water temperature	5kohm	Copper head
T3 – Ambient air temperature	5kohm	Plastic head
T4 – Discharge temperature	50kohm	Copper head
T5 – Outlet water temperature	5kohm	Copper head
T6 – Suction temperature	5kohm	Copper head
T7 – Water heat exchanger pipe temperature	5kohm	Copper head

3.8 Sensors position

T1 – Evaporator / defrosting

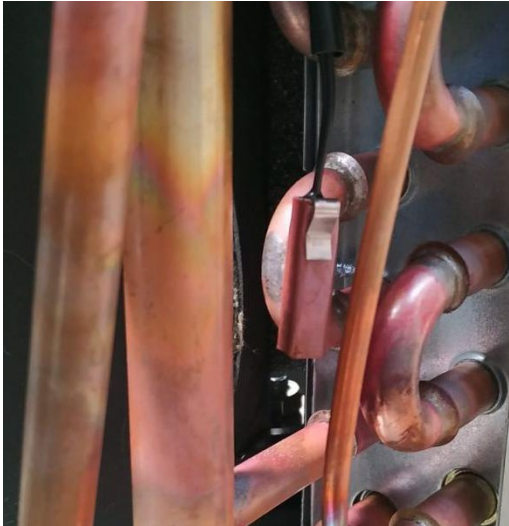

T2 – Inlet water temperature



T3 – Ambient air temperature

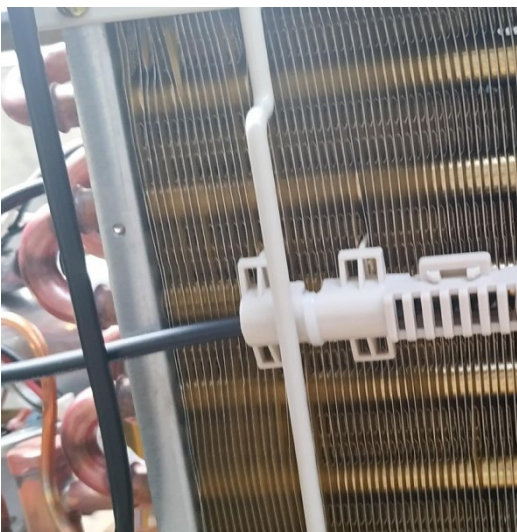

T4 – Compressor discharge temperature



T5 – Outlet water temperature



4. HEAT PUMP INSTALLATION AND CONNECTION

4.1 Positioning

The heat pump is designed for outdoor installation. It must be installed on a stable and levelled base. The pump can be installed in vertical position only.

- a) The heat pump should be installed in spaces where it can have sufficient supply of fresh ambient air. **Do not install the heat pump in closed spaces with limited air access and where the air cannot circulate sufficiently.** The air inlet and outlet must be completely accessible. The heat pump should have minimal distances from surrounding objects as shown on picture on the right. Do not put the heat pump near bushes or trees either, as these can also influence the air access. **Every single barrier of free air flow reduces the efficiency** of the heat pump and may lead to heat pump's malfunction, damage or failure.

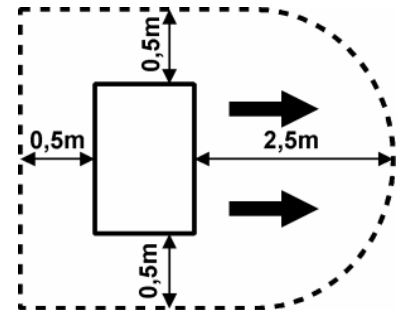

Picture: Minimal distances from surrounding objects.

- b) Although the heat pump is designed for exterior installation (sunlight, rain, snow) it is suggested to make a shelter / roof in order to protect its metal parts and thus ensure long term stability of color, metal chassis, etc.
- c) Do not install the device near road networks, as increased concentration of dust gradually decreases the heat exchange effectiveness.
- d) When heat pump is in full heating operation, it generates considerably colder air than ambient air temperature. It is thus advised not to install the heat pump at places, where cold air flow could cause any inconvenience (windows, terraces, etc.). Also, do not place the air outlet against the dominant winds.
- e) The distance between the swimming pool edge and the heat pump should not exceed 30 m. Please note that the longer interconnecting water piping is, the higher heat loss occurs, i.e. lower heating output and less efficiency is achieved. Practically this results in longer heating times and higher electricity bill. It is not advised to install the heat pump very close to swimming pool water surface.
- f) The heat pump must be placed on a flat, stable and levelled surface. The pump housing must be fixed to this surface with screws and rubber anti-vibration elements (silent blocks). Rubber anti-vibration elements not only reduce the noise level of the heat pump, but also help to eliminate the vibrations and thus they contribute to smoother heat pump operations and long term reliability. Please note that heat pump should be installed above the closest terrain level to allow the condensation water leak out of the heat pump. Please refer to *section 7.1 Water condensation*.
- g) The surface of the evaporator consists of aluminum fins. The fins are soft and can get mechanically damaged very easily. Please be careful when manipulating with the unit to avoid any damage.
- h) It is advised to install the condensing unit on a **stand 300-500mm above surrounding ground**. Heat pump installed directly on a surrounding ground can be easily immersed into snow and/or into frozen condensation. This can decrease heat pump's efficiency and performance and lead to heat pump malfunction, damage or failure.

Notice: Please discuss particular details of heat pump positioning and connection to the swimming pool water circuit with your swimming pool builder, distributor or reseller!

4.2 Connection to water filtration circuit

The heat pump must be connected to water circuit (filtration circuit) of the swimming pool in order to provide desired heating/cooling performance. The water flow through the exchanger of the heat pump must be in accordance with the designed value (*see chapter 3.1 Technical data*). Normally the heat pump is connected through a by-pass. It is then possible to adjust the water flow accordingly as filtration pumps may have different water flow performances.

The by-pass consists of 3 valves connected as shown in the picture below. Water normally flows from the filtration pump (right side) to the swimming pool (left side) through Valve 1. Heat pump is connected through Valve 2 (heat pump inlet) and Valve 3 (heat pump outlet).

Complete closure of Valves 2 and 3 with Valve 1 fully open means no water flow through the heat pump which means no heating or cooling provided by the heat pump.

Complete closure of Valve 1 with Valve 2 and 3 fully open means maximum amount of water flowing through the heat pump.

Normally the by-pass is set as shown on below picture.

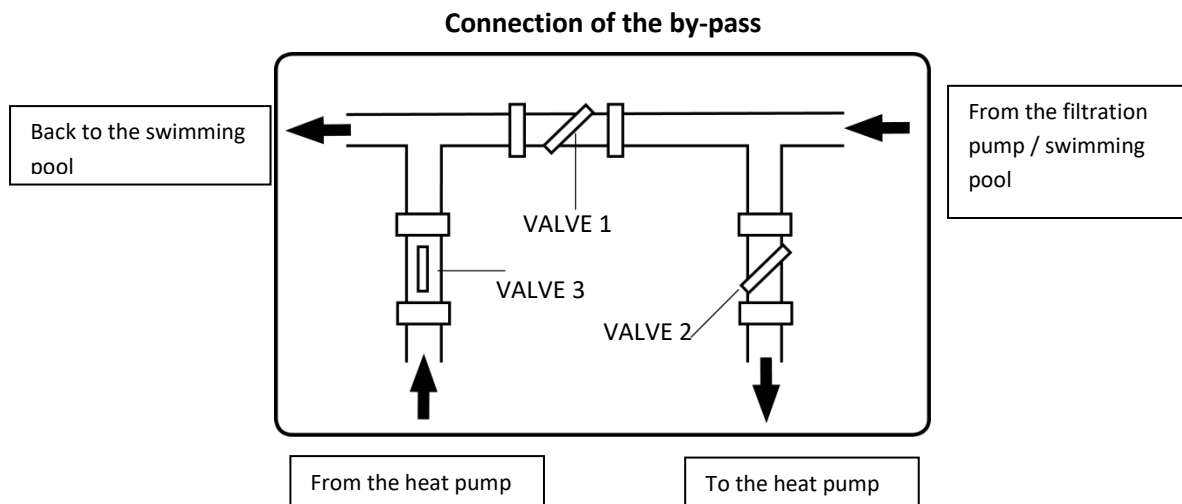

The heat pump is equipped with 2 threads enabling the connection of input and output fitting (d50). For connection with the filtration circuit use the d50 PVC pipe or 50/38mm adapters (6/4"). Please refer to *section 3.4 Description of the basic parts* in order to make sure which thread is water input and which water output. It is advised to apply lubricating oil on threads before tightening the connection.

Please consider using fast connector for the heat pump inlet and outlet in order to make the disconnection of the heat pump from the rest of the filtration circuit simple (for water draining from the heat pump before winter time and for service purposes).

The heat pump must be connected to the filtration circuit of the swimming pool behind the filter and in front of the device for water conditioning (automatic chlorine dosing machine, ozone machine).

For illustration please refer to **Scheme: Connection of the compact heat pump into the water filtration circuit of the swimming pool** on page 15.

Note: In case of using the automatic chlorine dosing machine in the filtration circuit it is necessary to install a backward titanium spring in front of it. If this valve is missing, by shutting down the filtration, the chlorine concentration around the heat pump exchanger may be increased to critical level and exceed the allowable level (3 ppm) causing damages.

4.3 Needed components for connection to water circuit

It is advised to use hose nut with external thread PN16 50 x 6/4" and a pressure hose D50 or PVC pipe D50. Particular component selection depends on individual condition at your pool. Your seller, distributor or pool builder may decide on how the actual connection is performed. These components are not part of heat pump package or delivery.

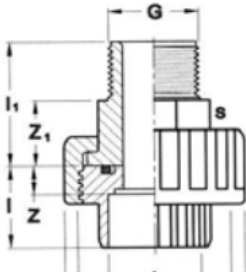

Picture: Hose nut with external thread PN16.
G=6/4" D=50mm



Picture: Pressure hose
D50

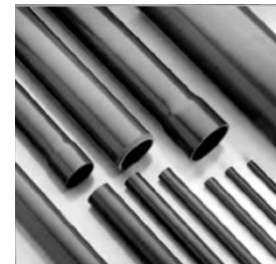

Picture: PVC pipe, various
dimesions

Sample connection scheme and application example

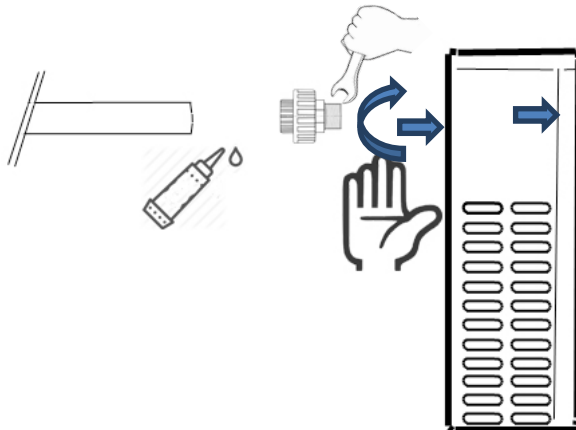

Picture: Sample water connection to the heat pump. Flexible hose glued onto hose nut adapter with external thred that is tightened into the heat pump exchanger thread.



Important: For proper operations, there must be a water flow through the heat pump exchanger in range of **8-10 m³/hour (HP2300) or 8-12 m³/hour (HP2800)**. In the case of water flow exceeding 12m³/h the heat pump will turn itself off and an error notice EE5 will pop up. Repeated error notice or repeated exposure of the heat pump to the water flow higher than 12m³/h will cause irreversibile damage to flow switch with permanent error notice EE5. The heat pump will be turned off. Please contact your distributor or service department, the flow switch needs to be replaced. Flow switch will also turn the heat pump off in the case of the water flow lower than 5m³/h. This is set up in order to protect the heat pump against overheating.



Error code ,EE5' advising of low / high water flow or damaged flow switch.

Scheme: Connection of the compact heat pump into the water filtration circuit of the swimming pool

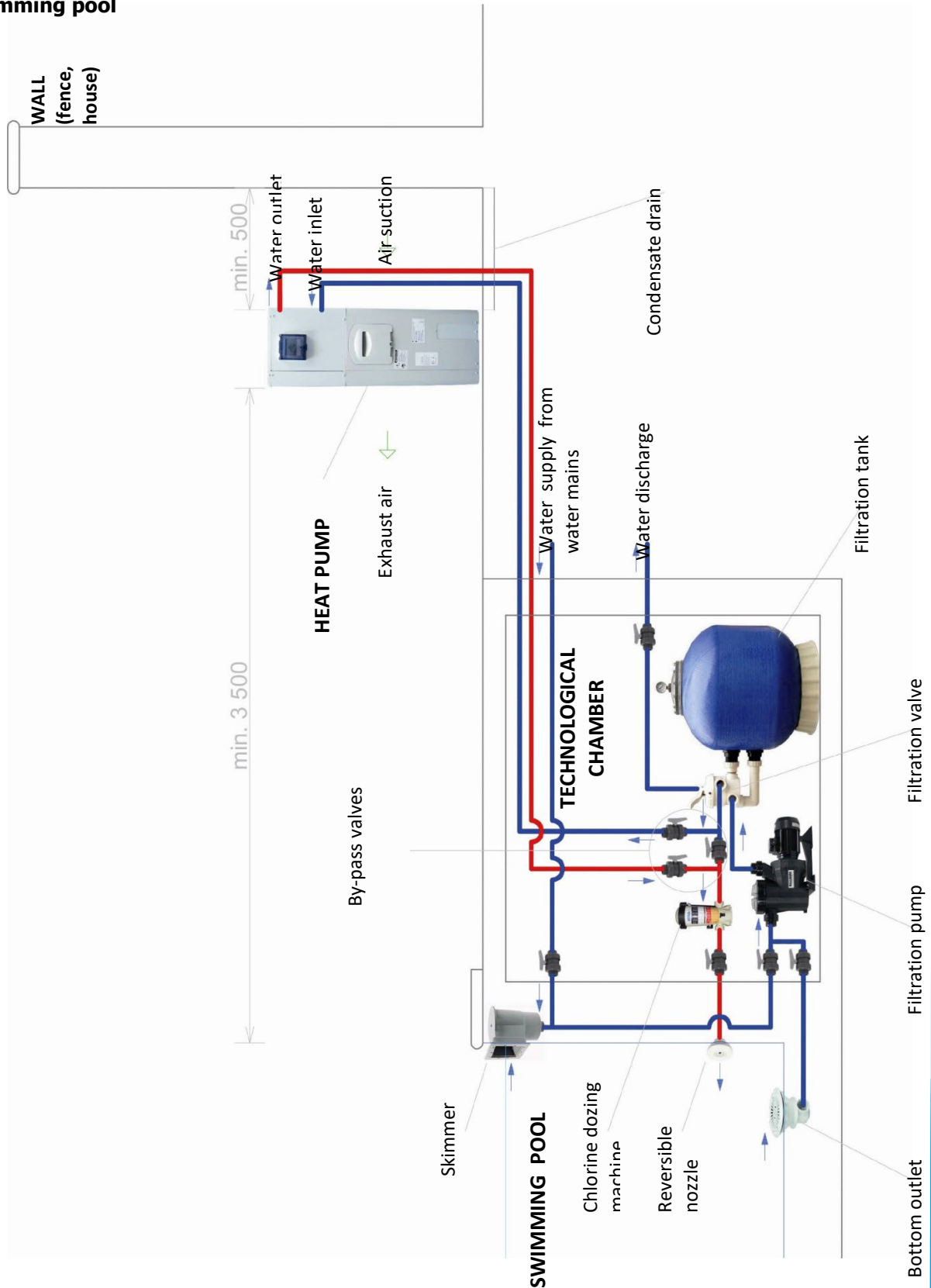

Note: The manufacturer supplies the heat pump only. The other parts and components shown in the picture are not included in heat pump package.

4.4 Electrical connection



IMPORTANT: The electric connection of the heat pump can only be performed by an authorized electrician in accordance with local electrical standards and requirements.



WARNING: The device operates at dangerous electrical current and voltage.

DANGER: Danger of electric shock!

- a) The heat pump must be connected through a single circuit-breaker specified in *section 3.1 Technical data* for a particular model. The dimensioning of the power supply must be sufficient (the suggested cross section of the conductors is 5 x 2,5 mm²). It is important to make sure and it is nonconditioned requirement of the manufacturer to install the heat pump together with **RCD (Residual Circuit Breaker)** with the actuating current up to 30mA. The power supply characteristics (voltage, phase and frequency) must be in complete compliance with the operating parameters of the device (please refer to *section 3.1 Technical data*).
- b) The electric connection must be performed by an authorized electrician and must be in accordance with the valid local electro-technical requirements.
- c) The electric installation of the heat pump must be grounded appropriately. The grounding distributor's impedance must be in compliance with local valid electro-technical requirements.
- d) The electro connection of the heat pump must be simple, clear and comprehensible. It is highly advised to have the connection performed in a way that would allow a third party electrician to understand the connection at no time. Unnecessary cross connections are not appropriate.
- e) It is important to carefully check and measure the electric installation before putting it into live operation.
- f) The suggested protection is stated in the chart below:

Heat pump model		HP 2300	HP 2800
RCD parameters	Current-carrying capacity	20 A/C	20 A/C
	Actuating current	30 mA	30 mA
Circuit breaker characteristic		20 A/C	20 A/C

- g) Block wiring diagram is included in *section 3.6 Block wiring diagram of the PCB board*.
- h) In order to protect the unit from weather anomalies it is recommended to install power surge protection class 1. B+C+D.

Note: Should above points a) to h) be in contrary with local electrical standards or requirements, please contact your distributor or reseller.

4.5 Multiple heat pump connection

Sometimes it is necessary to install multiple heat pumps into a single swimming pool in order achieve requested water temperature. Such installation is particularly advised on public venues where continuity of operation / service is paramount.

Installation of the multiple heat pumps follows the same procedure as single heat pump described above. It is only necessary to install the heat pumps in **parallel connection**. Serial connection would significantly decrease the heating/cooling capacity and efficiency of heat pumps second in line. It is advised to insert individual valves into connecting water piping for each single heat pump. This will

simplify the particular heat pump by-pass (disconnection) in the case of reinstallation, testing or service. Please refer to below illustration.

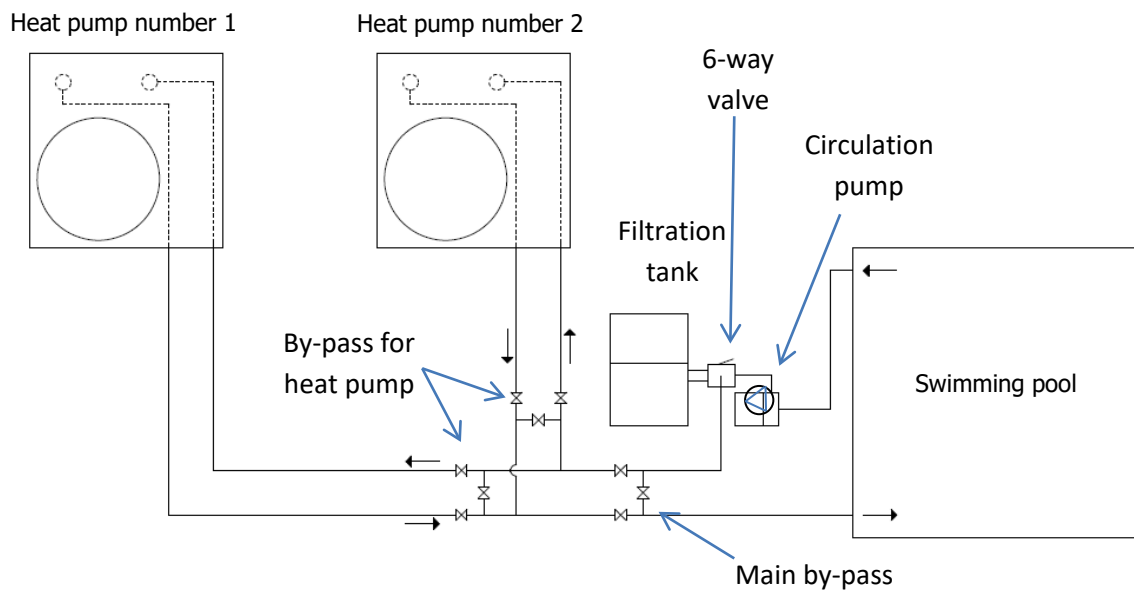

By multiple heat pump connection it is possible have all the heat pumps **always on** and running when heating / cooling is required **or** to have the heat pumps **gradually turning on and off** so at certain conditions (e.g. when requested water temperature is few degrees off the current water temperature) not all the heat pumps would run. Gradual turning on and off is achieved by setting the different requested water temperatures on multiple heat pumps. For example:

Heat pump 1	30°C
Heat pump 2	28°C

4.6 Seaside installation

Some condensing units are installed in locations close to sea or ocean. Please note that condensing unit should not be installed in areas where corrosive gases, such as acid or alkaline gas, are present or produced. Do not place the condensing unit where it can be exposed to direct sea wind (salty wind). This would lead into corrosion. This could result in heat pump malfunction, failure or damage. In any case you should avoid a direct exposure of sea wind. This can be done with the help of a windbreak (e.g. small wall). The dimensions of the windbreak should be 1.5 bigger than condensing unit in both height and width. Please leave 70cm of free space between the windbreak and the condensing unit.

Please check your unit on regular basis and it is advised to clean the unit more than once a year with water to remove salt particles.

Should you not be able to meet above, please speak to your distributor or reseller.

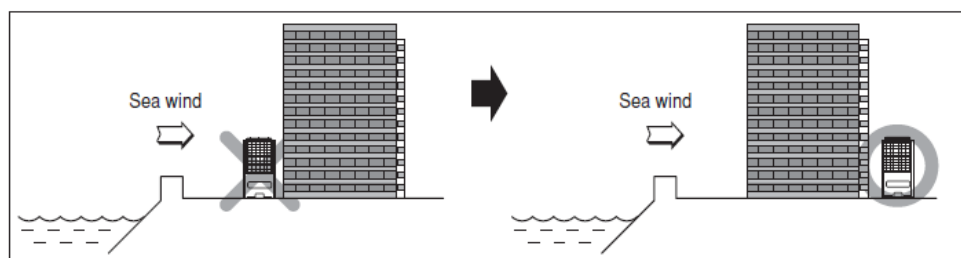

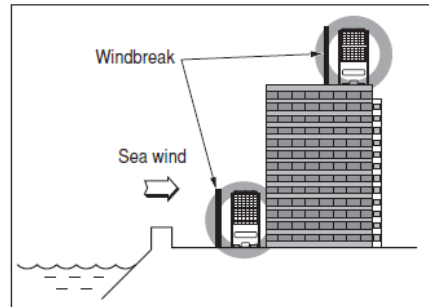

4.7 Control of the circulation pump

Microwell swimming pool heat pump is able to control the circulation pump. In principle should the heat pump be in need for heating/cooling it will automatically turn the circulation pump on.

In order to enable this control, the circulation pump must be connected to the heat pump electrically (please refer to section 3.6 Block wiring diagram of the PCB board). Normally the circulation pump is controlled by a time control of the filtration. It is thus advised to make the **parallel connection through power relay** enabling both sources of regulation (by the heat pump and by the time control).



Please note that both heat pump (phase R or 1) and the time control must be powered by the same single phase!



Please be advised that when circulation pump control is enabled and electrically connected with the heat pump, it is normal to have a situation when both the heat pump and the time control give command to circulation pump to operate at the same time. **It is thus strictly forbidden to power the heat pump (phase R) and the time control by different phases!**

The control is available in three modes:

1. Periodical mode

Heat pump will turn the circulation pump on only when it needs to heat or cool (i.e. requested water temperature is off the current temperature by at least 2°C).

Periodical mode can be set in manufacturing settings number 07, figure 0. (please refer to section 5.8 Setting of the operating parameters)

Periodical mode is also equipped with sampling, i.e. regular water temperature reading. Practically this means that as soon as the heat pump reaches requested temperature it turns itself and the circulation pump off. In the case the water temperature will not trigger the heat pump in following 60 minutes, the heat pump will automatically turn the circulation pump on for a 1 minute time in order to recirculate water from the pool into the heat exchanger in order to read the actual current water temperature.

2. Continuous mode

In continuous mode will the heat pump have the circulation pump turned on and running all the time the heat pump is in operational mode (please refer to section 5.2 General heat pump control for explanation of operational mode).

Continuous mode achieves better water temperature readings but means higher energy consumption of the system as the circulation pump is always on.

Continuous mode can be set in manufacturing settings number 07, figure 1. (please refer to section 5.8 Setting of the operating parameters)

3. microECONOMY+ Mode

microECONOMY+ mode provides optimum water temperature conditioning at lowest cost. Heat pump will have the circulation pump running only in time when the heat pump needs to heat or cool the water. Once the requested water temperature is achieved the heat pump goes into sleep

for 30 minutes. After these 30 minutes are passed, the heat pump will have the circulation pump running for about a minute to receive actual accurate water temperature. Should heating or cooling be required, the heat pumps starts. Should no action be required, the heat pump goes into 30 minute sleep again. This 30 minute period can be cancelled by pressing any button on the controller.

microECONOMY+ mode can be set in manufacturing settings number 07, figure 2. (please refer to section 5.8 Setting of the operating parameters)

Please note that all heat pump models may not be equipped with microECONOMY+ mode.

4.8 Separate water circuit

In order to save energy it is possible to install the heat pump on a separate water circuit with small circulation pump. This is appropriate in the case the power consumption of circulation pump for filtration is considered high or simply if the whole filtration circuit running is not desired when heating / cooling is required.

Normally swimming pool circulation pumps with water flow performance between 8-12m³/h consume up to 1kW of energy.

Such installation must be discussed with your swimming pool supplier, distributor or reseller.

4.9 Circulation pump connection

Manufacturer suggests connection of circulation pump through switching relay. Please refer to below drawing for more information. Direct connection of the circulation pump is not advised.

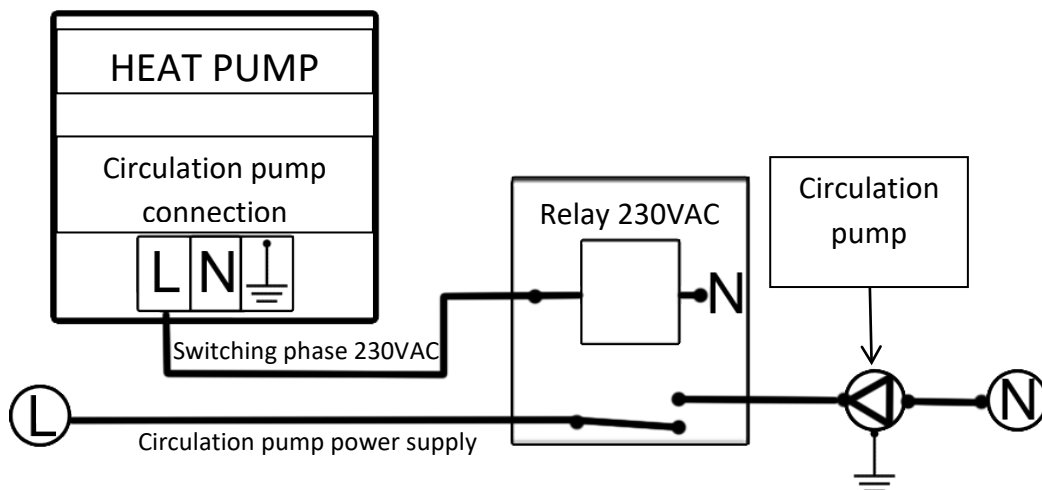

5. REGULATION

5.1 Description of the LCD panel

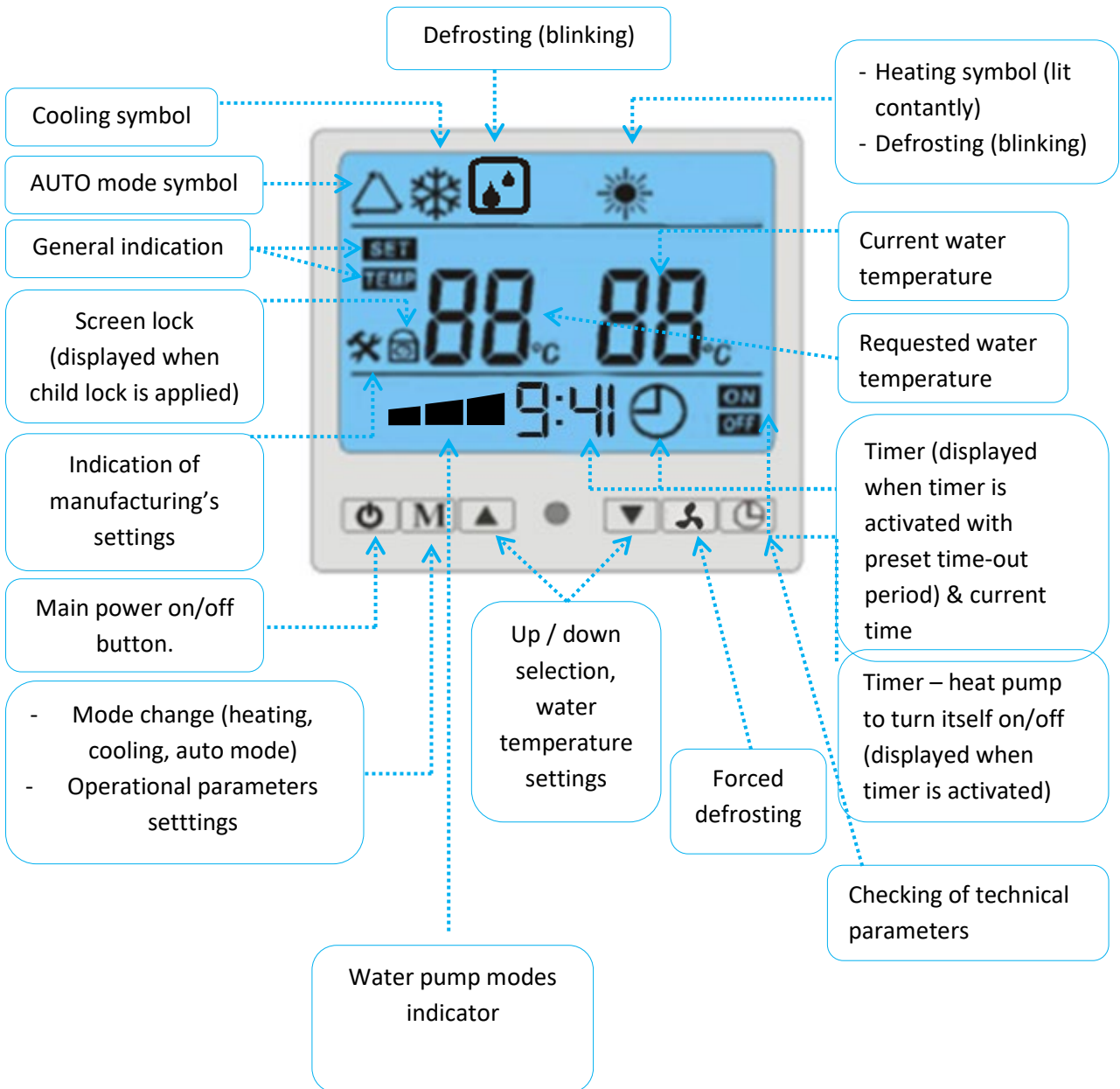

5.2 General heat pump control

After the installation, the heat pump is to be controlled by digital display only. Directly after installation with still no power supply to your heat pump, the digital controller will be blank. This means a complete shut down of the heat pump.

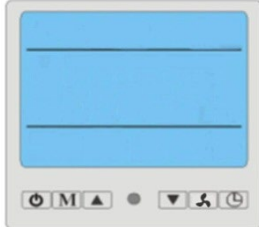

Picture: Blank display indicates no power supply and complete shutdown of the heat pump.

When heat pump receives required power supply, for a moment the display will show all its indications.



Picture: Display showing all its indication for a moment only when the heat pump receives power supply.

After few moments the heat pump will go into STAND-BY mode. This means that the heat pump is off but it is connected to the mains at the same time. The display will show the mode of the heat pump (in below picture a triangle that indicates AUTO mode) and the current water temperature, in below particular case 30°C.

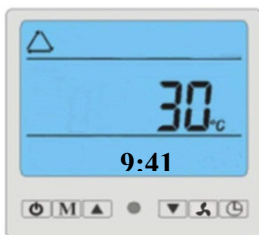

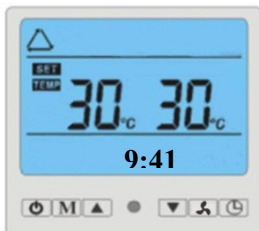

Picture: Stand-by mode.

By pressing the main power on/off button  you can turn your heat pump on to OPERATIONAL mode. The display will show the mode of the heat pump (in below picture a triangle that indicates AUTO mode), requested or desired water temperature on the left, showing 30°C in below picture, and current water temperature on the right, showing 30°C. Display show a actual time.



Picture: Operational mode.

You are able to set the requested water temperature. By pressing the up  and  down buttons the requested water temperature increases or decreases by 1°C. You will see immediate change of desired temperature on the left. The preset water temperature range is +5°C ~ +40°C.

Note: Some heat pump models require confirmation of requested water temperature if changed. This is done by pressing the main power on/off button .

By pressing the M button  you can change the operational mode of the heat pump. Please refer to *section 5.3 Heat pump operational modes* of this Installation and user manual.

By pressing the main power on/off button  you can turn your heat pump off. Under the temperature setting, Display show a actual time.

5.3 Heat pump operational modes

Auto mode

 - display shows a triangle symbol and a description 'AUTO'. Heat pump automatically keeps the requested water temperature. This means that heat pump automatically heats or cools when the difference between water temperature and the requested water temperature is 2 degrees of Celsius. The temperature difference of 2 degrees of Celsius is called Hysteresis. It is possible to change this settings (please see section 5.8 Setting of the operating parameters, point 10).

Heating

 - display shows a sun symbol. Heat pump only heats the water. This means that the heat pump turns itself off after a requested water temperature is reached. Heat pump turns itself on again when the water temperature decreases by 2 degrees of Celsius below the requested water temperature. The temperature difference of 2 degrees of Celsius is called Hysteresis. It is possible to change this settings (please see section 5.8 Setting of the operating parameters, point 10).

Cooling

 - display shows a snow flake symbol. Heat pump turns itself off after a requested water temperature is reached. Heat pump turns itself on again when the water temperature increases by 2 degrees of Celsius below the requested water temperature. The temperature difference of 2 degrees of Celsius is called Hysteresis. It is possible to change this settings (please see section 5.8 Setting of the operating parameters, point 10).



Recommendation: Manufacturer recommends heat pump regulation by AUTO-MODE.







Warning: Manufacturer does not recommend changing of hysteresis settings. It may be changed by an experienced user only.

5.4 Clock

Actual system clock is shown on the display.

How to set the clock:

When in stand-by mode or normal operating mode, press the „Fan“ and  buttons together for 3 seconds to enter clock setup. Time in „hh:mm“ 24h format starts blinking. By pressing  button user cycles between hours (hh) and minutes (mm) – the selected is blinking. By pressing   buttons user can set the hours or minutes. Do nothing for a few seconds or press “Fan” button to save the actual system clock.

Note: Please check the system clock in case of power dropout

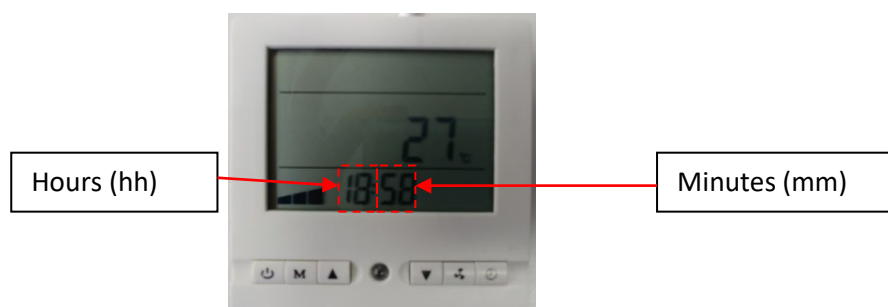



5.5 Timer

It is possible to have your heat pump turned on and/or off automatically by timer function.



Automatic turning on

You can use this function when you would like your heat pump turned on at a specific time of day. You set the 'Timer on' function in STAND-BY mode (heat pump off and connected to the mains) by pressing the "Fan" and "Down arrow" buttons together for 3 seconds.

"Timer"  icon is displayed and Timer clock (hh:mm) starts blinking together with the "On" icon. By pressing  button user cycles between hours (hh) and minutes (mm) – the selected is blinking. By pressing  buttons user can set the hours or minutes. Take no action for a few seconds to save the values and activate automatic turning on. The display reverts back to displaying actual system clock and the "Timer" and "On" icons are displayed next to it.

Automatic turning off

You can use this function when you would like your heat pump turned off at a specific time of day. You set the 'Timer off' function in OPERATING mode (heat pump on) by pressing the "Fan" and "Down arrow" buttons together for 3 seconds.

"Timer"  icon is displayed and Timer clock (hh:mm) starts blinking together with the "Off" icon. By pressing  button user cycles between hours (hh) and minutes (mm) – the selected is blinking. By pressing  buttons user can set the hours or minutes. Take no action for a few seconds to save the values and activate automatic turning off. The display reverts back to displaying actual system clock and the "Timer" and "Off" icons are displayed next to it.

The actual system clock is shown on the display by default. If Timer on and/or Timer Off are set then user can cycle between displaying them by pushing "Timer"  icon.

To cancel the Timer On:

In stand-by mode press the "Fan" and "Down arrow" buttons together for 3 seconds. When the Timer clock starts blinking press the "Fan" button shortly. This cancels the Timer.

To cancel the Timer Off:

In operating mode press the "Fan" and "Down arrow" buttons together for 3 seconds. When the Timer clock starts blinking press the "Fan" button shortly. This cancels the Timer.

Note: Timers are cancelled in case of power dropout.



Timer Off is set





Timer On is set



Both Timers are set

5.6 Child lock

Your heat pump controller allows you to lock its settings in order to protect them from undesired changes. This is mainly used in the case of a risk that children would unintentionally change the settings of the heat pump.

By pressing and holding both buttons   for 5 seconds at the same time, the child lock gets activated. In order to deactivate the child lock, please repress and hold the buttons again for 5 seconds.

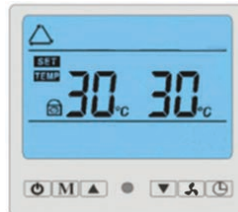

Picture: Child lock activated. A lock icon is showed on the left.

5.7 Parameters check

During heat pump operations (heating or cooling) you can read several basic technical parameters. This is mainly useful for a service technician.

Following parameters can be checked:

Parameter code	Meaning of parameter	Display range
30	Inlet water temperature (T2)	-9~99
31	Ambient air temperature (T3)	-9~99
32	Discharge temperature (T4)	10~C5 (125)
33	Evaporator temperature (T1)	-9~99
34	Outlet water temperature (T5)	-9~99
35	Suction temperature (T6)	-9~99
36	Water heat exchanger pipe temperature (T7)	-9~99
37	Number of EEV steps	0-50P (x10)



Picture: Parameters check, input water temperature 30°C.

In order to enter the Parameters check reading please press and hold the clock button  for 3 seconds during the heat pump's operational mode. The parameters will be displayed starting with parameter '14' (showing at position of requested water temperature – on the left) with particular measured value, e.g. '30' (showing at position of current water temperature – on the right). For example 14 30 would mean that the water temperature on the input to the heat pump (swimming pool output) is 30°C.

Then repress the „clock“ button to display the parameters in sequence (parameters from 14 to 18).



Note: 10 seconds after the last pressing of the button, the display switches over to the display of the operational mode.

5.8 Setting of the operating parameters

It is possible to change preset technical parameters of your heat pump. Please be advised that the manufacturer has fine-tuned the technical parameters in order to achieve the best possible operations and efficiency. Thus a change in these settings is not advised.

Should there be a need to change manufacturing settings please discuss the matter with your seller or distributor alternatively with the manufacturer. Change in preset settings may lead into heat pump undesired performance issues, inefficiency, malfunction, failure or damage. Change can only be performed by trained technician.

Your heat pump enables settings of 16 operational parameters. Please note that only trained technician is allowed to perform change in manufacturing preset settings.

- In STAND-BY mode (heat pump off) press and hold the „M“ button  for 3 seconds. The parameters will be displayed starting with parameter '00' (showing at position of requested water temperature – on the left) with particular preset setting, e.g. '0' (showing at position of current water temperature – on the right).
- Then repress the „M“ button to display the parameters in sequence (parameters from 00 to 14, see the chart below).
- The requested value is adjusted by pressing the  and  buttons on the particular parameter.



By keeping the „M“ button pressed for 3 seconds in the operating mode, you can enter the reading of preset technical parameters, however you cannot change them. For more information please see *section 5.7 Parameters check*.



Figure	Meaning	Range	Manufacturing setting
00	Setting of the requested max. water temperature	0/1~45/60°C	0
01	Temperature setting for the beginning of the defrosting	-20°~10°C	-7°C to -3 °C
02	Temperature setting for the end of the defrosting	5°~45°C	13°C to 16°C
03	Setting of the defrosting time period	30 ~ 150 min.	45 min to 30 min
04	Setting of the forced defrosting time period	1 ~ 15 min.	3 min.
05	Setting of the compressor´s protection temperature	70 ~ 110°C	105°C
06	Temperature for 4-way valve activation	0 ~ 60°C	7°C
07	Working mode of the circulation pump (0 = Periodical / 1 = Continuous / 2 = microECONOMY+)	0 ~ 2	2*
08	Restart after power cut	0 ~ 1 (0-no, 1-yes)	1
09	Type (0-only heating, 1-heating+cooling, 2- cooling only, 3-heating+two exchangers)	0 ~ 3	1
10	Hysteresis - difference between the current and requested water	1 ~ 10°C	2°C

Figure	Meaning	Range	Manufacturing setting
	temperature for the regulation start-up		
11	Sensor T2 correction	-10...+10	0
12	Water temperature outlet limit (0 = -5°C / 1 = +5°C)	0-1	1**
13	Sensor T5 correction	-10...+10	0
14	Heat pump cleaning	0-1	0
15	Timer On enable	0-1	0
16	Timer Off enable	0-1	0
17	Dry contact on/off	0 - deactivated 1 - activated	0
18	Fan turning On/Off logic activation/deactivation	0 - deactivated 1 - activated	0
19	Temperature value (C1) when the fan have to be turned off in COOLING mode	-10 ~ +20 C	10
20	Temperature value (C2) when the fan have to be turned off in HEATING mode	+20 ~ +60 C	40
21	Cooling mode duration after every 3rd defrost cycle (with turned ON fan)	0 ~ 20 min.	2-5
22	Condensate drain heating cycle adjust	0~30 min.	10
23	Target overheat in HEATING mode	-10~+10°C	5
24	Auto/Manual EEV	0 - manual 1 - auto	1
25	Initial EEV position	10~48 (x10 steps)	35
26	Minimum EEV position	0~20 (x10 steps)	10
27	Maximum EEV position	35~50 (x10 steps)	50
28	EEV direction	0 - default 1 - reversed	0
29	Target overheat in COOLING mode	-10~+10°C	5

* - only available at certain heat pump models. If not available then mode 0 is preset.

** - do not set this setting to "0" unless only a non-freezing liquid instead of water is circulated through the heat pump!

Note: The manufacturing settings may differ from the data in the chart.

Note: 10 seconds after the last pressing of the button, the display switches over to the standard display of the requested water temperature/current water temperature (while running), or the current water temperature in STAND-BY mode.

Note: Display board is showing parameters 00-14 only because parameters 15 and 16 (Timer On and Timer Off) can be enabled/disabled through button combination. Parameters 15 and 16 are available through android/iOS app.

5.9 Remote display placement and WIFI



On demand it is possible to place the display remotely from the heat pump. This is made with 30 meter cable and wall plaster box. Alternatively you can install WIFI module (in the case you ordered it) by heat pump or by display. Below schemes picture the connection schematics.

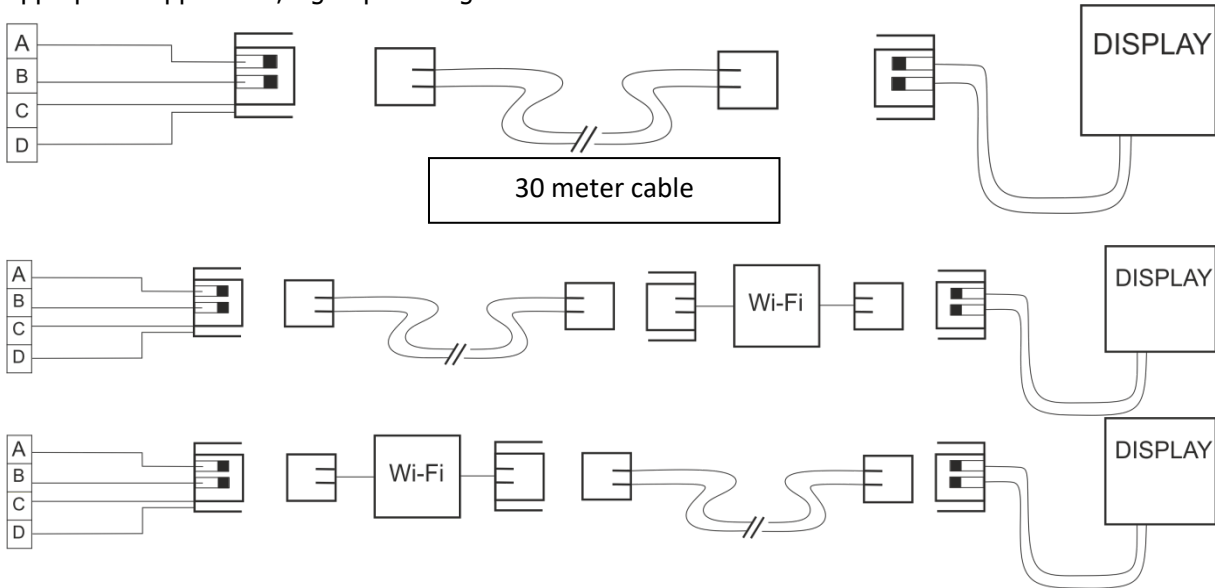



For the exact WIFI instructions please turn to separate instructions about WIFI – there you will find appropriate application, sign up and log in instructions.



Notice: Manufacturer reserves the right to change parameters or controller functions without notice.

5.10 Phase monitor specification







- Off state /heat pump off, no power supply, etc./ 

Normal operations	Missing phase
 RUN  PWR	 RUN  2x PWR

- Incorrect order of the phases / ^{flashing} incorrect phase sequence



- Overcurrent (adjustable by pins/jumpers)

T4 (L3, T)	T3 (L2, S)	T2 (L1, R)
 RUN  3x flashing PWR	 RUN  4x flashing PWR	 RUN  5x flashing PWR

In the case of Error message EEA, you need to remove the front right metal panel and check the phase protection PCB for the number of red LED “PWR” flashing cycles.

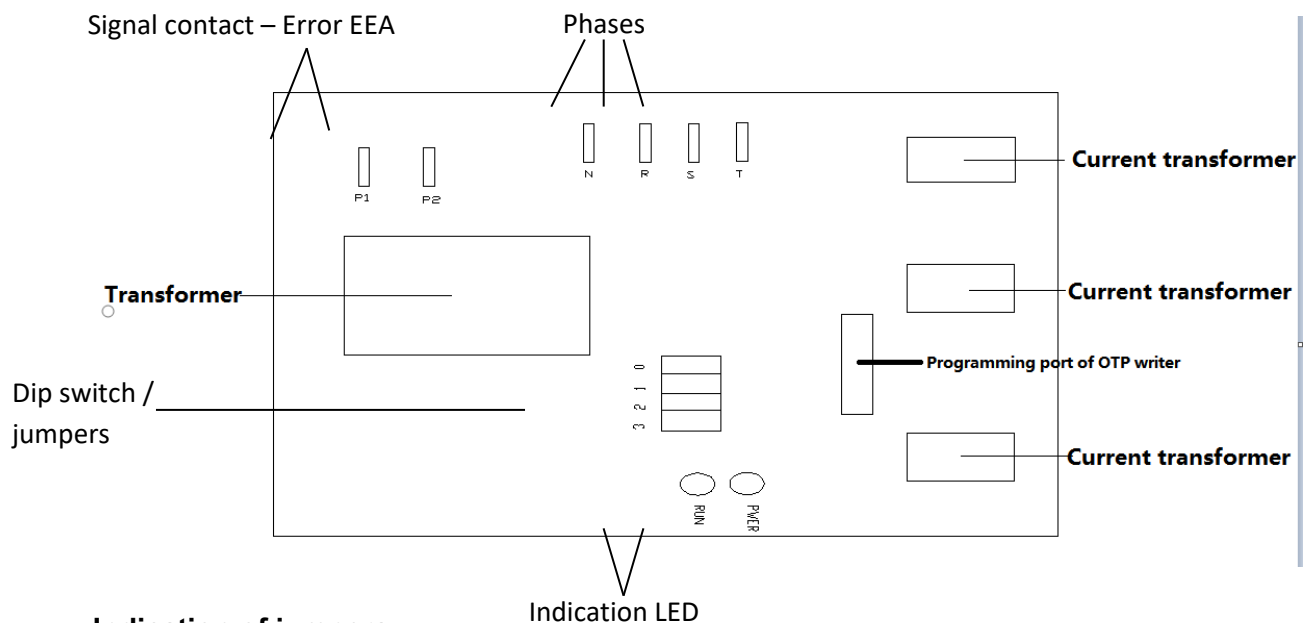

- Indication of jumpers:
(0 means close, 1 means disconnection)

Option of jumper wire CN2				Value of current protection
3	2	1	0	
0	0	0	0	6.5A
0	0	0	1	7.5A
0	0	1	0	9A

3	2	1	0	Value of current protection
0	0	1	1	10A
0	1	0	0	11A
0	1	0	1	12A
0	1	1	0	13A
0	1	1	1	14A
1	0	0	0	16A
1	0	0	1	18A
1	0	1	0	20A
1	0	1	1	21A
1	1	0	0	23A
1	1	0	1	25A
1	1	1	0	28A
1	1	1	1	30A

6. ACCESSORIES

6.1 Winter module

Winter module has been designed for effective operations of the heat pump at subzero ambient air temperatures. It heats the lower part of the compressor (oil tank) resulting in higher oil viscosity which subsequently eases the compressor operations. Winter module is automatically activated when the compressor is off and ambient air temperature is below -5°C . After the heat pump is turned on, i.e. after compressor is turned on, winter module turns itself automatically off. User is not required to perform any action towards heat pump regulation. System works fully automatically. Power consumption is 45W. In the case the heat pump will not be used in winter time, along with winterizing, it is suggested to turn the heat pump's circuit breaker off in order to avoid unnecessary energy consumption. Winter module is on demand and is not supplied with each heat pump by standard.

6.2 Heat exchanger frost protection

Frost protection for heat exchanger ensures protection of the water heat exchanger against rapid ambient air temperature variation under the subzero temperatures. It is a heating spiral which is attached onto the heat exchanger body. Heat exchanger frost protection can generally protect the heat exchanger; however it is not advised to expose the heat exchanger to extremely low temperatures (e.g. -15°C) for long term with water filtration turned off.

Please be advised that local ambient air temperature around your condensing unit may be lower than the one measured for example at the external wall of your house. This may be caused by various factors (for example wind). Please be advised that connection water piping outside of the water heat exchanger is not protected by the heat exchanger frost protection. Heat exchanger frost protection is automatically regulated. It turns itself on if the ambient air temperature decreases below 2°C . Power consumption is 64W. In the case the heat pump will not be used in winter time, along with

winterizing, it is suggested to turn the heat pump's circuit breaker off in order to avoid unnecessary energy consumption. Heat exchanger frost protection is on demand and is not supplied with each heat pump by standard.

6.3 Condensate tray defrost

Condensate tray defrost ensures protection of the tray against frost. This is created in the case the heat pump works in subzero ambient air temperatures. When heat pump defreezes itself, water drops are flowing from the evaporator fins into the condensate tray. In the case, the tray is not equipped with active defrost, gathered water continuously transforms into ice. In the case the ice reaches the evaporator, it can cause its damage. Condensate tray defrost is a heating spiral which is attached onto the tray.

Please be advised that local ambient air temperature around your condensing unit may be lower than the one measured for example at the external wall of your house. This may be caused by various factors (for example wind). Please be advised that connection water piping outside of the water heat exchanger is not protected by the heat exchanger frost protection. Heat exchanger frost protection is automatically regulated. It turns itself on if the ambient air temperature decreases below 2°C. Power consumption is 64W. In the case the heat pump will not be used in winter time, along with winterizing, it is suggested to turn the heat pump's circuit breaker off in order to avoid unnecessary energy consumption. Condensate tray frost protection is on demand and is not supplied with each heat pump by standard.

6.4 Protection cover

Protection cover /braced up PVC/ is designed for heat pump coverage for a period when the heat pump is not in operations (it is winterized or water is removed from heat exchanger and the electricity is disconnected). Protection cover should be put onto the heat pump from above and should be fixed with a string at the bottom against wind. It is strictly forbidden to turn the heat pump on and operate it with the protection cover on. This situation would cause insufficient amount of air (energy) for heat pumps operations which would lead to almost none performance both by heating and cooling. This situation would almost immediately lead to heat pump overheating which could cause a malfunction, damage or a complete failure of the heat pump. Warranty does not cover any heat pump damage or other damage caused by heat pump operations with the protection cover on.

7. HINTS AND TIPS

7.1 Water condensation

It is normal to have water dropping or leaking from the evaporator during heat pump operations, particularly during heating. During heating, the evaporator is normally cold. It can easily reach dew point conditions. Dew point means that at given air temperature and relative humidity any surface that is of below dew point temperature condensates the water from surrounding air.



Condensation can result even in liters of water being leaked out of the heat pump. If you suspect a leak on water circuit, as a first step it is advised to check if it is condensation. The condensed water flows over the evaporator lamellas into the casing base. Then flows out through a plastic fitting designed for connection to the 3/4" PVC tube by which the condensate can be taken to an appropriate drain.

1. Turn off the device and leave only the swimming pool pump (circulation pump) in operation. If the water stops to flow out, then it is condensing water.
2. Test, whether there is any chlorine or salt found in the outflowing water (if chlorine or salt are used). If there is no chlorine or salt, then it is a condensate.

7.2 Defrosting

As described in section 3.5 Security and control systems, your heat pump is equipped with active defrost protection. Defrost protection has following modes:

1. **Normal defrosting** – defrosting gets activated in the case heat pump measures low temperature of the evaporator (sensor T1) (-7°C). It is possible to change this setting. Manufacturer has preset the settings for optimal heat pump operations.
2. **Cyclical defrosting** – this mode gets activated if evaporator temperature sensor fails (T1). In this situation your heat pump does not have a measured input if defrosting should be activated or not. Thus in order to protect the heat pump it will automatically defreeze itself in 45min intervals.
3. **Forced defrosting** – this mode can only be activated manually by pressing and holding  button for 5 seconds.

Heat pump signalizes defrosting by flashing the icon  and sun icon  permanently on.

7.3 On-Off Contact

- a) Your heat pump is equipped with a potential free on/off contact. This enables you to turn the unit on from stand-by mode or turn the unit off from operations into a stand-by mode. Should you wish to activate the on/off contact please change settings 17 to '1'. Please refer to section 5.8. Setting of operation parameters.
- b) When on/off contact is disabled (parameter 17 is set to ,0'), then control of the pump is through the display or WIFI. When on/off is enabled (parameter 17 is set to ,1'), then the highest priority has the potential free contact. If the contact is open (disconnected), then the heat pump is in stand-by mode. In stand-by mode the heat pump does not heat or cool. When the contact is closed (connected), the heat pump is turned into an "ON" mode. You are then able to set all settings through display or WIFI. On/Off contact is used by main house switches, pool room or Jacuzzi switches, they are also manually controlled.
- c) The dry contact pins are potential free and they are not supported by any voltage source. So they..... 5VDC. Do not connect 230V phase onto this potential free contact. Low voltage electronics is directly connected with this on-off contact, in the case it is connected to 230V it will lead to damage and the whole heat pump malfunction.

7.4 Winterizing

Your heat pump continuously contains water in its water heat exchanger. This water will freeze up and damage irreversibly the heat exchanger if exposed to sub-zero air temperatures, normally during winter time. It is then necessary to prepare the heat pump for sub-zero air temperatures (e.g. winter time). Generally, the water from inside the water heat exchanger must be removed. Winterizing is done on heat pumps which do not operate all year round. In the case you operate your heat pump all year round and/or also in winter months when ambient air temperature decreases below 0°C it is necessary to ensure continuous water circulation through the water heat exchanger with water of temperature at least 20°C. In the case this is not done, water inside the water heat exchanger may cool down and subsequently freeze up which causes destructive damage to heat exchanger and the heat pump will no longer be operational. Warranty excludes such damage.

Winterizing:

1. Disconnect the heat pump from the mains (e.g. by turning the circuit breaker off).
2. Close the bypass valves number 2 and 3 (Please refer to *section 4.2 Connection to water filtration circuit*).
3. Unscrew the nut



4. Open the cover



5. Connect the hose and open the valve



6. After the water leaked out, please repeat the steps in reversed order from point 5 of this section. The drain valve must be closed tightly.



Please make sure that all water is removed from the heat exchanger before sub-zero air ambient temperatures period (e.g. winter time). Damage of the heat exchanger resulting from frost is excluded from warranty.



7.5 Heat pump season start

After winter time you need to prepare your heat pump for new season. In general please refer to this Installation and user Manual. Heat pump must be connected to the mains, water circuit; it must comply with positioning requirements.

During the initial start of the heat pump it is possible to have EE5 error. This signals low, high or none water flow and results in heat pump turning off. If your water piping is intact, circulation pump

operates in order; the reason for this initial report may be air bubbles in water system. These tend to gather around the flowswitch and thus cause incorrect indication of water flow.

In order to remove the water bubbles from the system you need to bleed the water circuit to remove any outstanding air.

7.6 Pool cooling at tropical conditions

Swimming pool heat pump may be used to cool swimming pool water at tropical conditions. This means cooling of water up to 35°C temperature by up to 45°C ambient air temperature. At these conditions, the heat pump is operating at edge of its engineering design. It is thus necessary to perform several steps to ensure proper product operations.

1. Heat pump's capacity must be properly sized – required cooling load for the pool is not higher than 70% of actual heat pump's or multiple heat pumps' cooling capacity.
2. Heat pump(s) is (are) installed in accordance to this User's Manual.
3. **Water flow is set to minimum 1.2-1.8 m³/h when cooling.** This typically results in delta T (difference between water IN – parameter 30 and water OUT – parameter 34 – for more information please check 5.7 Parameters check) of 5°C to 9°C.
4. When a heat pump cools the water, the air on the outlet (front of the heat pump) is considerably warmer than on the inlet. For example by 40°C ambient air temperature (air IN), the air OUT of the heat pump reaches 50°C and more. It is thus imparent not to install parallel heat pumps in direction of the outlet of the other heat pump. Should you be unsure about atual heat pumps positioning, pelase consult with your distributor or manufacturer. Please see below drawings.

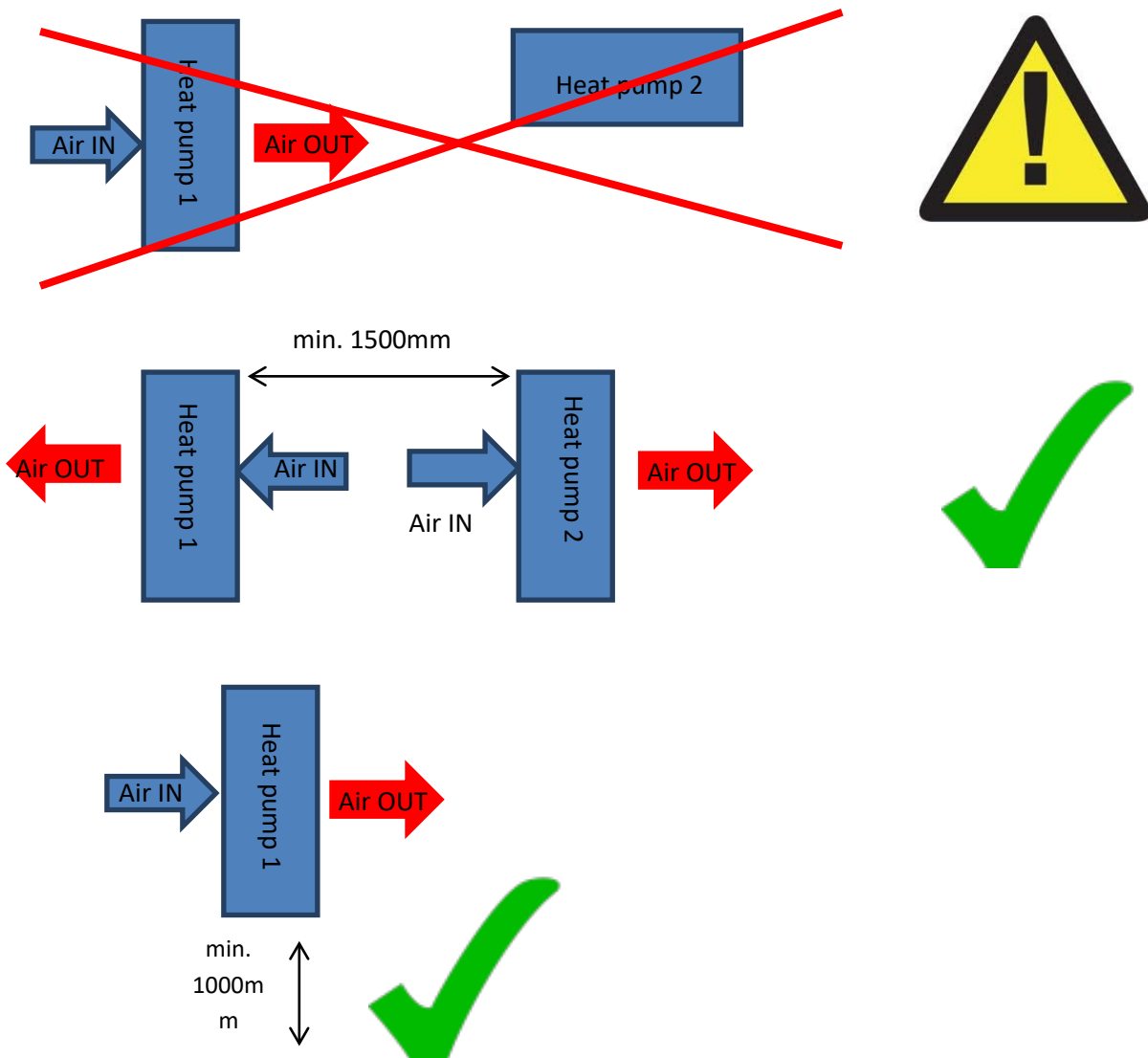

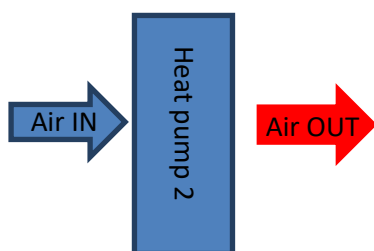

7.7 Failure reports

Please find below table containing list of failure reports with their explanation and suggested solution. In order to physically locate the sensor please refer *to section 3.6 Block wiring diagram of the PCB board*.

Failure report (displayed on display)	Operating status of the heat pump	Description of the failure report	Sensor	Failure report resolution
EE0	Heat pump in forced heating mode.	Anti-freeze protection		If the heat pump is in stand-by mode and water temperature of the inlet water T2 is equal or less than +2 °C, antifreeze protection will be activated automatically. The heat pump will automatically try to reach water temperature +7 °C (turn on into heating mode). After this temperature is reached, the heat pump goes automatically back to stand-by mode. Can be recovered automatically
EE1	Heat pump decommissioned; acoustic warning	Water temperature sensor failure (T2) / interrupted or short-circuited sensor	5kΩ	Check the sensor, possibly change the sensor
EE2	Heat pump decommissioned	Surrounding air temperature sensor failure (T3) / interrupted or short-circuited sensor	5kΩ	Check the sensor, possibly change the sensor
EE3	Heat pump decommissioned; Acoustic warning	Compressor discharge sensor failure (T4) / interrupted or short-circuited sensor	50kΩ	Check the sensor, possibly change the sensor
EE4	Optical warning Timed defrosting	Evaporator temperature sensor failure (T1) / interrupted or short-circuited sensor	5kΩ	Check the sensor, possibly change the sensor
EE5	Heat pump decommissioned in app. 1-2 minutes after turning on; acoustic warning	None/Weak/High water flow; No closure of the flow switch or failure of the flow switch	Flow switch	Set the water flow to 4-6m ³ /h or check the flow switch
EE6 (please)	Heat pump decommissioned;	High temperature on compressor discharge	50kΩ	Please refer <i>to section 5.2 Troubleshooting</i>

do not mistaken for EEb)	acoustic warning	(T4)		
EE7	Optical warning	Electric leakage protection	-	Check the power supply of the unit, circuit breaker. In order to remove EE7 optical warning, power supply needs to be turned off and on
EE8	Acoustic warning	Failure of the cable communication of the controller	-	Check the control cable between the control board and the control digital panel
EE9	Heat pump decommissioned	High/Low pressure switch protection		In order to remove EE9 optical warning, power supply needs to be turned off and on
-09	Heat pump decommissioned	Temperature sensor(s) failure	5kΩ	Temperature sensors or their bus inputs are burnt out. Sensors and/or possible the whole regulator with motherboard must be replaced.
EE C	Heat pump decommissioned	Ambient air temperature lower than -15°C	-	Please check ambient air temperature of the condensing unit. Should the temperature be lower than -15°C, the heat pump will not work due to security reasons. In such case there is seemingly nothing wrong with your heat pump. Should the air temperature be higher than -13°C, the sensor and/or motherboard must be replaced.
EEd	Heat pump decommissioned	Outlet water temp. sensor (T5) failure	5kΩ	Can be recovered automatically. This fault can activate only if parameter no.9 is set to 3 (two w/exchangers)
EEb (please do not mistaken for EE6)	Heat pump works in limited regime.	Suction temp. sensor (T6) failure	5kΩ	Heat pump continues working but cannot regulate EEV so EEV will be set to default during this fault. Can be recovered automatically or replace the sensor.
EEF	Heat pump works in limited regime.	W/exchanger pipe temp. sensor (T7) failure	5kΩ	Heat pump continues working but cannot regulate EEV so EEV will be set to default during this fault. Can be recovered automatically or replace the sensor.
EEA	Heat pump turned off, eventually fan spinning	Phase monitor activation	-	Turn to separate instruction about Phase monitor specification section 5.10

7.8 Troubleshooting – save time and money

Problem	Cause	Solution
The unit does not work, the display is blank.	The heat pump is not connected to the mains or does not have power supply or circuit breaker is off.	Check the heat pump's connection to the mains and circuit breaker. Check the power supply connection to terminal of the heat pump.
The heat pump does not start although connection seems OK.	The heat pump is not connected to the mains or does not have power supply or circuit breaker is off or there is incorrect order of the phases.	Check the heat pump's connection to the mains and circuit breaker. Check order of the phases.
The heat pump does not heat (cools) the water.	Desired water temperature equals current.	Everything is OK. It is normal that the heat pump does not operate.
	Heat pump does not work for 3 minutes and then it starts.	This is normal. It is time protection for compressor.
	The heat pump is set for cooling (heating) only.	Set the heat pump to heating (cooling) or Auto mode.
	The heat pump is in stand-by mode.	Turn the heat pump on.
	There is no water flow through the heat pump (possibly EE5 is signalled).	Ensure proper water flow of 8-10m ³ /h(HP2300) / 8-12m ³ /h(HP2800) through the heat pump.
	Heat pump has technical problem signalled through failure reports (EE.).	Please <i>check section 5.1 Failure reports</i> .
Heat pump has iced up evaporator but does not defreeze.		Check value for figure 17 / <i>Section 5.7 Parameters check</i> . The figure must be sub-zero. If it's below zero your heat pump should initiate defrosting shortly. If it's above zero, then it is likely displaced. Sensor must be placed correctly.
		EE4 failure report is signalled by digital control panel. Your heat pump will automatically defreeze itself in 45min cycles. You can force your heat pump to immediate defrosting / <i>Section 7.2 Defrosting</i> .
The heat pump works but water temperature increases slowly or does not at all.	Heat pump operates short period of time.	The water temperature difference between inlet and outlet is normal to be 1°C to 1.5°C. During initial heating it is normal to take up to 72 hours to reach desired water temperature.
	Water flow through the heat pump is low.	Check the by-pass valves settings / <i>Section 4.2 Connection to water filtration circuit</i> .
	Pool size is too big for the heat pump.	Speak with your distributor or reseller and double check the correct capacity for your pool.
	Insufficient air flow. Heat pump's evaporator or air flow is blocked by trees, dirt, building, etc.	Please check the heat pump for correct positioning / <i>Section 4.1 Positioning</i> .

Digital control display signals EE6.	High pressure on compressor discharge.	Check if evaporator is not dirty, blocked by any objects (trees, leaves, etc.). Check water flow. This error can be caused by high ambient air temperatures as well as the water temperatures (above 35°C) or problem on refrigerant circuit (leakage, restriction, not enough refrigerant, etc.) If this error occurs repeatedly, please contact your distributor or reseller.
Other	Other	Please call for service.

8. MAINTANANCE & WARRANTY

8.1 Maintenance



WARNING: The device operates at dangerous electrical current and voltage.

DANGER: Danger of electric shock!

WARNING: The device is pressurized with refrigerant R410A. The pressures can reach as high as 30bar.



- a) Clean the swimming pool and the filtration on regular basis to prevent the device from damage caused by dirty or clogged filter.
- b) Check the power supply on regular basis.
- c) Should the device appear to operate in unusual way, turn it off immediately and contact your distributor or seller.
- d) Check the working area of the pump on regular basis (see the picture in *chapter 4.1 Positioning*). Keep this area clean and remove all the accumulated dirt, leaves, snow, trees or anything that can increase the risk of air circulation blockage.
- e) If you decide not to use the heat pump, disconnect it from the mains, remove the water from the heat exchanger (please refer to *section 7.4 Winterizing*). It is advised then to cover the unit with a water resistant sheet or with a PE foil.
- f) For external washing of the heat pump, use your common cleaning agent for dishes and pure water.
- g) Clean the external surface of the evaporator with a soft brush on regular basis to remove impurities. This is particularly important during bloom months. Please note that every single barrier of free air flow reduces the efficiency of the heat pump and may lead to heat pump's malfunction, damage or failure.
- h) Check the evaporator surface and make sure that the lamellas are not compressed. It is possible to flatten out the lamellas by a flat, non-edgy tool. Please be advised that the evaporator fins are easy to compress mechanically. The warranty does not cover any mechanical damage caused on the lamellas.
- i) Regularly check the screws, fixing the device to the base, screws fixing the covers.
- j) Depending on aggressivity of exterior environment (acid rain, chemical industry in vicinity, high UV, sea or ocean in vicinity, etc.) it is possible for a rust to appear on metal parts. It is suggested to treat this rust in order to avoid its spread.
- k) Do not clean inner parts of water heat exchanger with hot water. The heat exchanger will get damaged if water temperature inside it rises above 45°C.
- l) All the above measures must be performed by a trained technician.
- m) The maintenance of the refrigeration or electrical system must be performed by authorized technicians only.

8.2 Warranty

Your heat pump is covered by warranty. For particular conditions of this warranty in terms of warranty period and subject please refer to your local regulations and/or agreement with your distributor, reseller or installer. Any action resulting in damage of the heat pump, property or other damage caused by improper usage of this product or in contrary with this Installation and user manual is excluded from warranty coverage.

Distributed by:

Manufacturer:



MICROWELL, spol. s r.o.
SNP 2018/42, 927 01 Sala, Slovakia



tel.: +421/31/770 70 82
e-mail: microwell@microwell.sk



www.microwell.eu
Made in Slovakia

