



Wi-Fi module for HP BLACK INVERTER swimming pool heat pump

Registration and pairing guide

Available on the
App Store

GET IT ON
Google Play

By downloading and using this application You accept that Microwell, spol. s.r.o. is a third-party application broker and is not responsible for any technical conditions of its use.

User Privacy Instructions

We take your privacy very seriously and we promise to inform you how we use the data. Users' private data, such as mailboxes, address, before uploading to the cloud, we will get your permission, and we will work hard to protect your data security.

Description

- Receive data signal from cloud server and transmit to the main device;
- Receive data signal from main device and transmit to cloud server;
- To achieve remote upgrade the WIFI module baseplate MCU by cloud server;
- To achieve the remote upgrade of the main device by WIFI module baseplate MCU.

Technical Parameters

OPERATING VOLTAGE: DC8V~12V (Recommended value 12V)

OPERATING CURRENT: Max. recurrent peak 1A, average standby current 50mA

TEMP. RANGE: Operating Temp.: -30°C~+70°C; Storage Temp.: -40°C~+85°C

LED INDICATOR LIGHT: 4 lights, Network configuration indicator, router connection indicator, cloud server connection indicator, 485 communication indicator;

DIMENSION (L×W×H) : 78mm×63mm×24mm

Transmit frequency: 2412-2472 MHz

Transmit power max. : < 20dbm

Installation

There is a magnet on the back of the WIFI module, it can be installed indoors or outdoors, and avoid direct sunlight;

Please scan the following QR code to download APP;



Functional Description

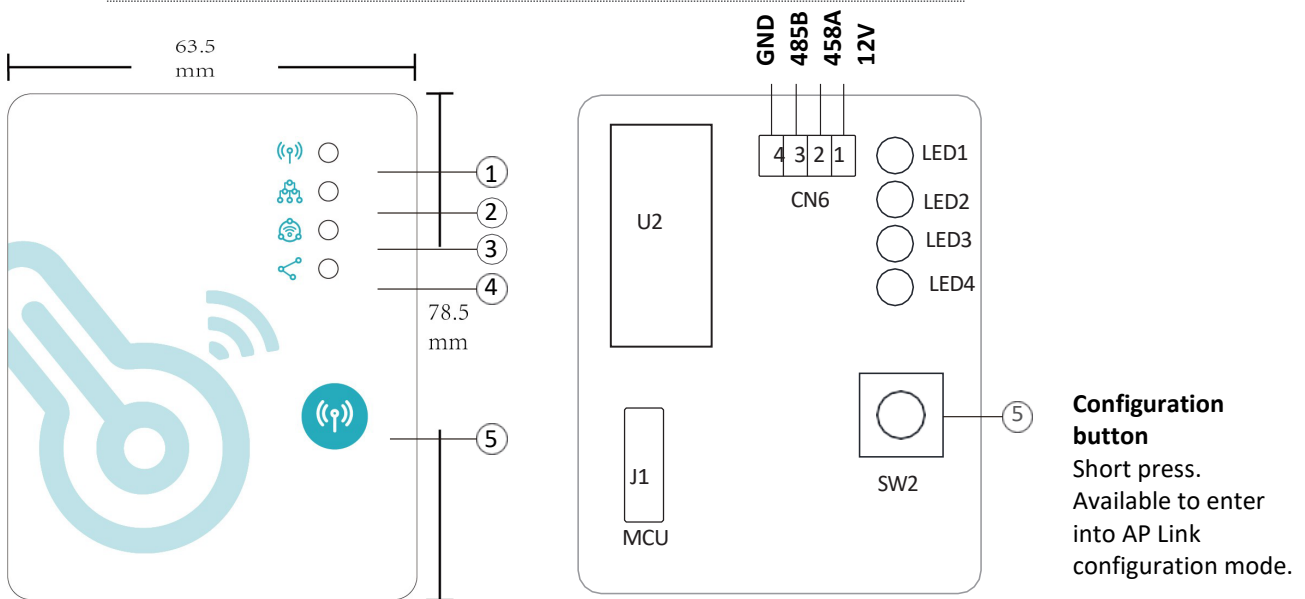

ITEM	NAME	LONG LIGHT	SLOW FLASH	EXTINGUISH
①	Network configuration indicator	Configuring Network	SmartLink configuring	Done
②	Router connection indicator	Normal	Abnormal	---
③	Cloud server connection indicator	Normal	Abnormal	---
④	485 communication indicator	Normal	Abnormal	---

Account Login

Use email address and password to register, login or reset the password.

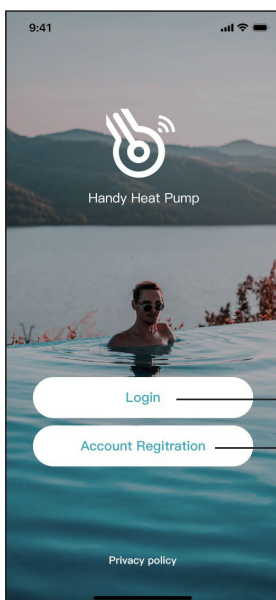

Fig.1 Home page

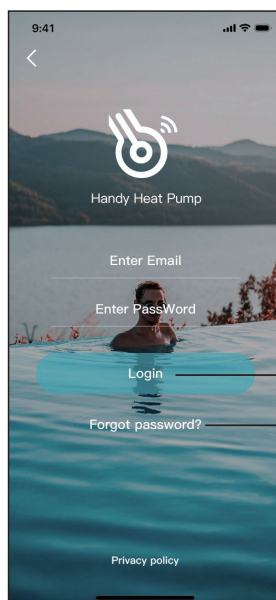

Fig.2 Login interface

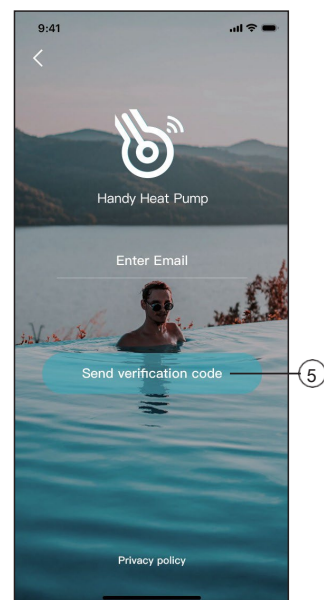

Fig.3 Register and retrieve passwords

1. Account registration: Click ① (Fig. 1) on the home page to jump to the account registration interface (Fig. 3).
2. Login: Click ② (Fig. 1) on the home page to jump to the login interface (Fig.2) and follow the instructions on the page (as shown in the figure).Enter your registered email address and password, and click ③ to jump to the device list.
3. Forgot Password: When you forget your password, click ④ (Fig.2) and jump to the password forgotten interface (Fig.3). Fill in the relevant information according to the page instructions, click ⑤ to send the email verification code, and operate according to the page instructions.

Add Device

After logging, displays My Device interface (Fig. 4) , follow the instruction to add WIFI or DTU.

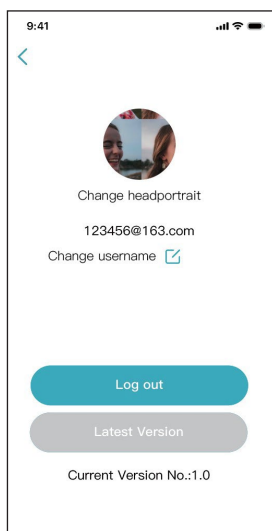

Fig.5 The left-hand menu

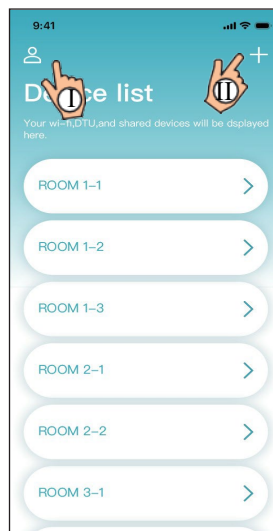

Fig.4 My device interface

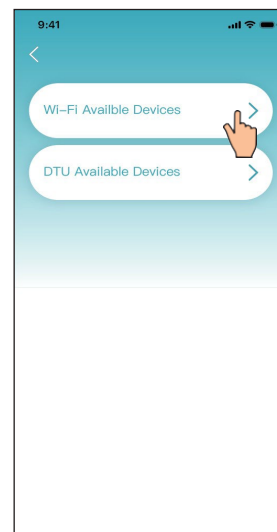

Fig.6 Add device interface

WiFi Configure Network

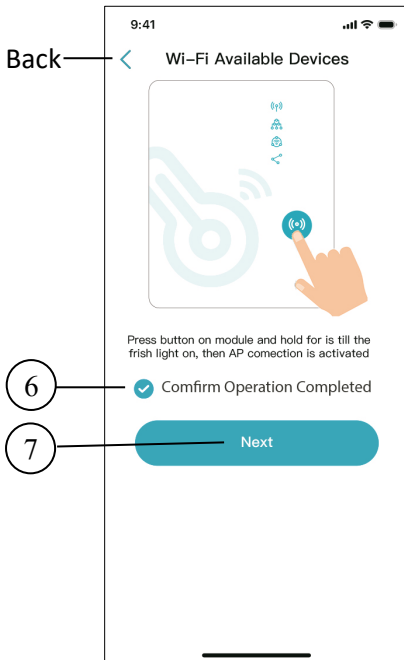

Fig.7 WiFi Module on interface

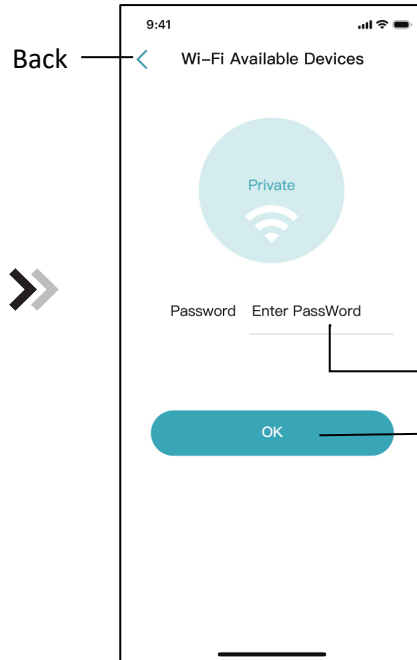

Fig.8 Enter password interface

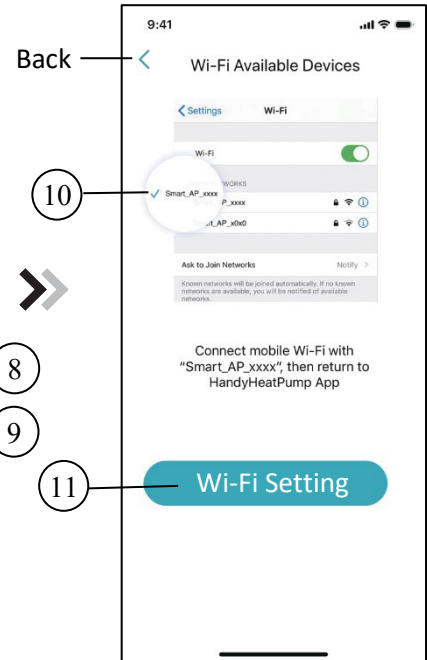

Fig.9 Connect specified

1. Follow the instructions on the page (Fig.7), press button on module and hold for 1s till two lights on, then AP connection is activated, click 6 to confirm, click 7 to turn the page;
2. Click 8 to enter the WIFI password for the current connection, click 9 to confirm;
3. Jump to system settings, connect specified WIFI, click 10 to select the "Smart_AP_xxx", click 11 to popup window(Fig.10), follow the instruction and then jump to WIFI setting interface(Fig.11).

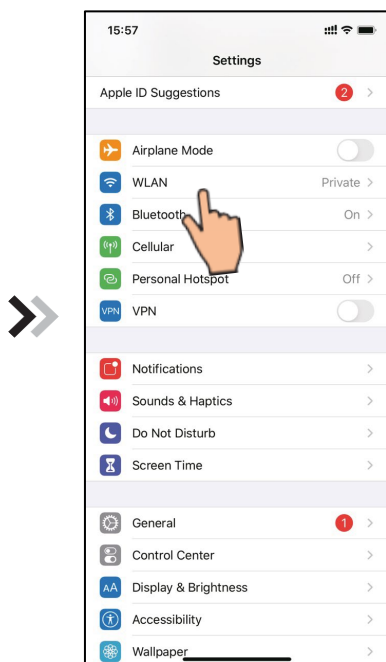

Fig.10 Setting interface

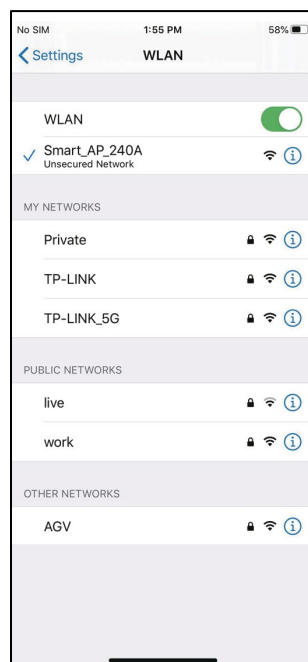

Fig.11 WiFi setting interface

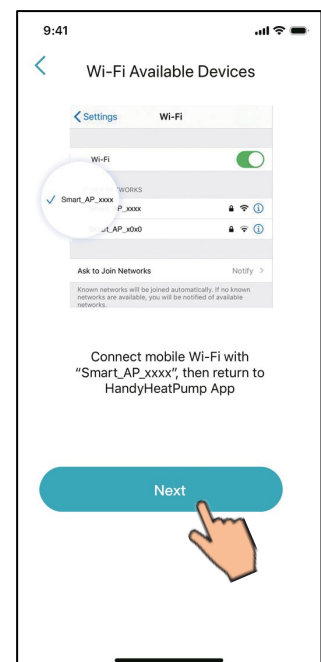

Fig.12 Connect specified WiFi

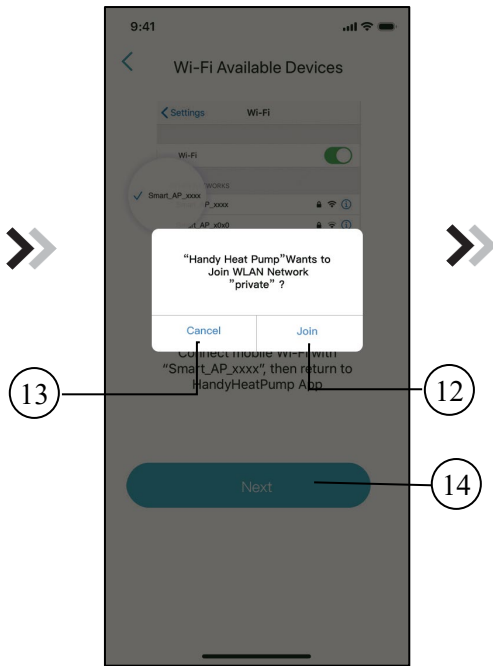

Fig.13 Configure Network interface

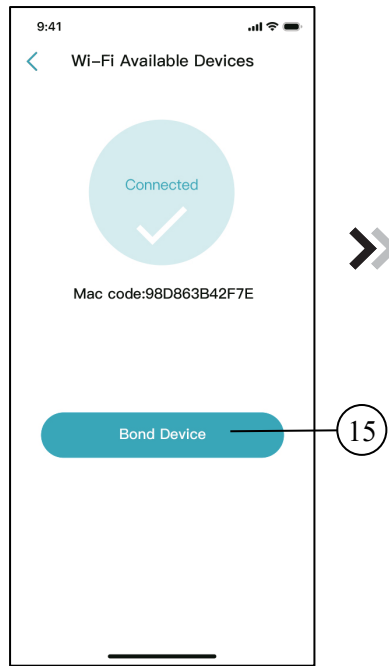

Fig.14 Bond Device interface

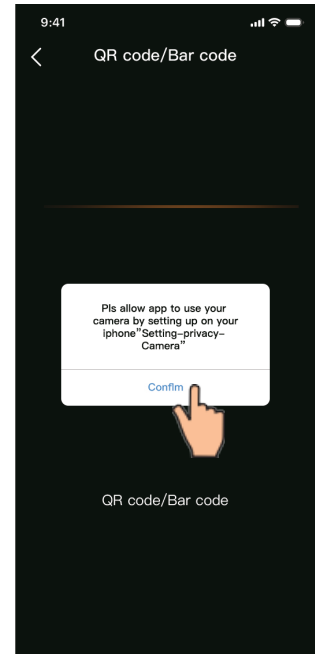

Fig.15 Scanning interface

4. Slide the page back to configure network interface (Fig. 12), click (13) to cancel, Click (12) to popup window (Fig. 10), connect to the available WIFI network, and slide back to the page to configure the network. Click (14) to turn next page (Fig. 13); click (15) to bond device (Fig. 14);
5. Click "OK" (Fig.15) to allow the App to use the camera for scanning the WH barcode on the heat pump unit (Fig.16);
6. Click "OK", device bond is done (Fig.17);
7. After WIFI and DTU bonding is done, and jump back to My Device (Fig. 18).



Fig.16 WH barcode

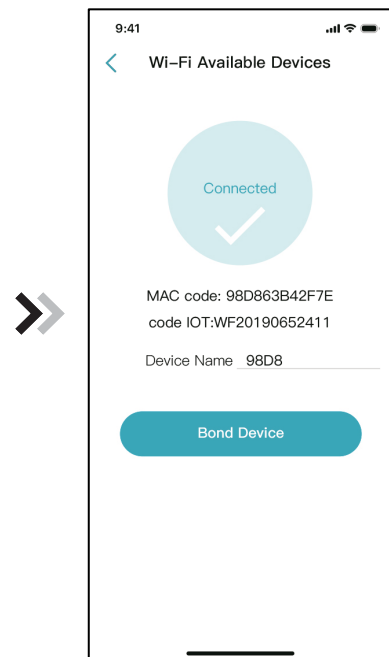

Fig.17 Bond Device done interface

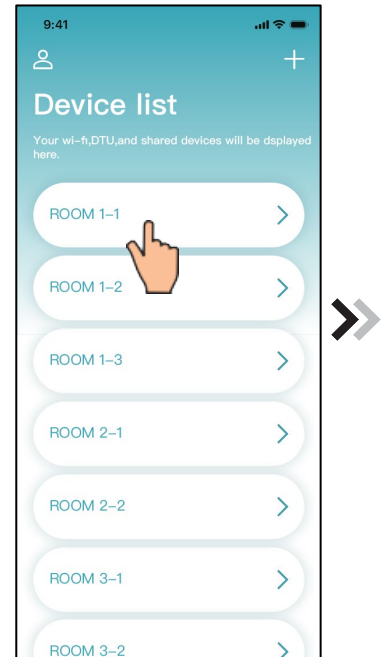

Fig.18 Device management interface

Device Management

Device management operations are as below:

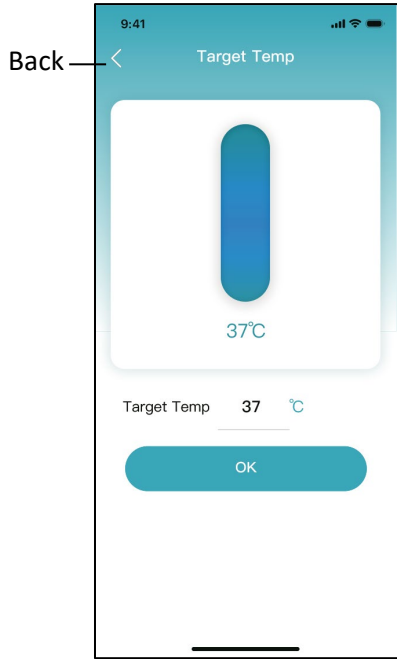

Fig.20 Modify target temperature

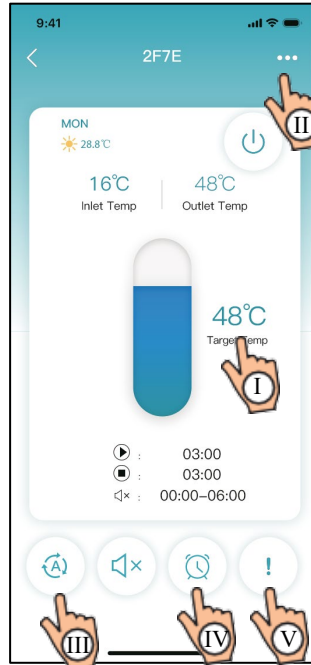

Fig.19 Device main interface

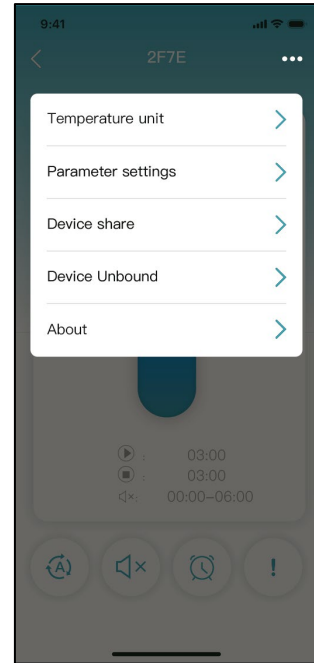

Fig.21 The right -hand menu interface

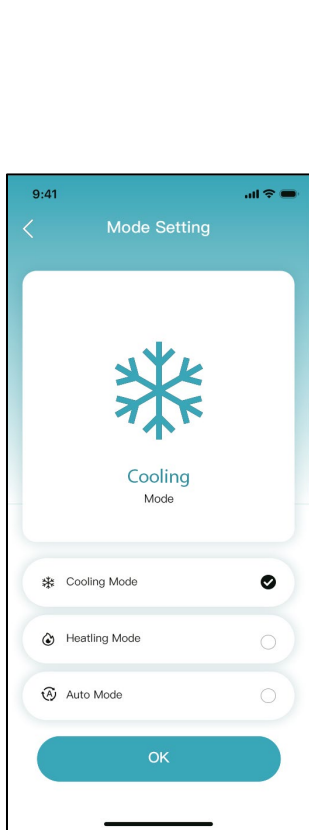

Fig.22 Modify mode

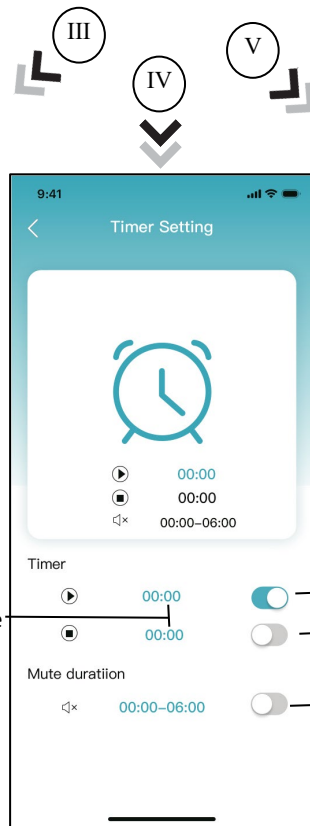

Fig.23 Timing Setting interface

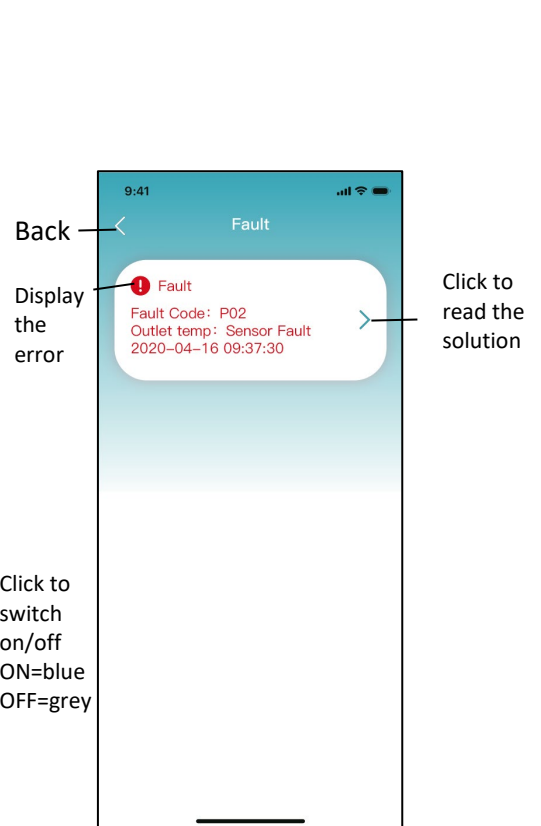









Fig.24 Troubleshooting interface

ICON	NAME	FUNCTIONS
	ON/OFF	Click it to turn on/ off the unit
	Silent Mode Off	Display silent mode off, click it to activate the silent mode
	Silent Mode On	Display silent mode on, click it to turn off the silent mode
	Mode shift	Mode changing: Cooling,Heating,Auto
	Cooling	Display Cooling mode, click it to change operating mode
	Heating	Display Heating mode, click it to change operating mode
	Auto	Display Auto mode, click it to change operating mode
	Timing setting	Click it to jump to the timer on/ off and mute timer setting interface
	Troubleshooting	Click it to jump to the troubleshooting interface



Manufacturer:

MICROWELL, spol. s r.o.
SNP 2018/42, 927 01 Sala,
Slovakia



tel.: +421/31/770 7082



e-mail: microwell@microwell.sk

www.microwell.eu

Made in Slovakia



Distributed by: