



User's and installation manual

SWIMMING POOL DEHUMIDIFIER

Model:
DRY SIREN mono
DRY SIREN due



Version: 01/2020





Thank you for purchasing Microwell swimming pool dehumidifier DRY SIREN. You hold in your hands probably the most advanced and most futuristic device for your pool. Before you use this device, it is necessary to carefully read the entire User's manual. Please keep the User's manual available in the case a reference is required in the future. Please provide this information also to each user of the device. Please mind local regulations in your country regarding installation and usage of this dehumidifier which are valid in addition to this User's manual.

1. CONTENT

1. CONTENT	2
2. WASTE DISPOSAL INFORMATION	4
3. SAFETY MEASURES	4
3.2 USAGE PRECAUTIONS	5
3.3 HANDLING PRECAUTIONS.....	6
4. PARTS LIST	7
5. TOOL LIST	11
6. INSTALLATION – CEILING UNIT	12
6.1 BASIC MANIPULATION	13
6.2 APPROPRIATE POSITION OF CEILING UNIT.....	15
6.3 FIXATION ON A CEILING – CONCRETE / WOOD	17
7. INSTALLATION – COMPRESSOR UNIT	33
8. INSTALLATION – ELECTRICAL CONNECTION	34
9. DRAINAGE OF CONDENSATE WATER	39
10. INSTALLATION – REFRIGERANT CONNECTION	41
10.1 DETERMINING THE PIPE LENGTH AND REFRIGERANT CHARGE.....	41
10.2 REFRIGERANT PIPING	42
10.3 FLARING WORK	43
11. UNIT TEST – PAIRING	47
11.1 AFTER PAIRING, TEST RUN	59
12. MOBILE APPLICATION - INSTRUCTIONS FOR USE	59
12.1 CONTROL.....	59
13. TECHNICAL DATA	64
13.1 TECHNICAL DATA TABLE	64
13.2 EXTRACTION RATE DIAGRAM	65
13.3 WIRING DIAGRAM	65
14. HINTS & TIPS	66
14.1 ERROR MESSAGES	66
14.2 TROUBLESHOOTING – SAVE TIME AND MONEY	68

14.3	MAINTENANCE.....	70
14.4	SUMMER SHUT-DOWN.....	70
14.5	SUPER-CHLORINATION CLEANING.....	71
14.6	START-UP DURING CONSTRUCTION.....	71
14.7	MICROLIGHT+	71
15.	WARRANTY.....	72
15.1	INSTALLATION CHECK-LIST AND WARRANTY CARD	73

2. WASTE DISPOSAL INFORMATION

When using this dehumidifier in the European countries, the following information must be followed:

DISPOSAL: Do not dispose this product as unsorted municipal waste. It is prohibited to dispose this dehumidifier in domestic / household waste. It is prohibited to dispose this appliance into forests or natural landscape. This could lead into local soil pollution. Collection of such waste must be treated individually.



DISPOSAL POSSIBILITIES:

1. The municipality has established a collection system where electronic waste can be disposed.
2. When buying a new product, the retailer or the manufacturer may take back the old appliance free of charge.
3. As old appliance may contain valuable resources which could be sold to scrap material dealers.
4. Disposal of packaging materials such as carton box or plastic / bubble foil can be recycled.



3. SAFETY MEASURES

This device is primarily designed for use in indoor swimming pool, sauna or spa. Alternative use is in laundries, drying rooms or other humid areas requiring dehumidification.

Model Microwell **DRY SIREN** is designed for halls with swimming pool surface of up to 60m².



For proper and optimal operations of the device is it necessary to maintain the air temperature in the swimming pool room / hall 2-3°C higher than actual water temperature in the pool. It is also necessary to keep the air temperature in the swimming pool room / hall in operational temperature range of the dehumidifier (specified in Technical data section). Higher temperatures than operational temperature range may cause damage to the unit resulting from overheating of the unit.

It is necessary to follow instructions in this User's manual and local regulations in your country that regulate the installation and usage of this device. Incorrect, improper or operations contradictory to this User's manual may lead to an injury or property damage and will lead to loss of warranty. To prevent injury or property damage the following instructions must be followed:

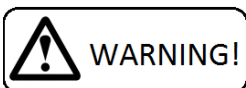

3.1 ELECTRICAL SAFETY

- The device operates at dangerous electrical current.

- Only authorized person with particular electro-technical qualification can manipulate with unit.
- Danger of electrical shock.
- Do not exceed the required power supply.
- Do not turn the device on that shows signs of possible damage such as broken packaging, broken or otherwise damaged unit's chassis or cover, smoke, smell, etc.
- It is necessary to use appropriate Residual current circuit breaker (RCD) for connection of the dehumidifier to main power supply.
- Do not manipulate with the device with wet hands.
- Do not clean the device with water.
- Before cleaning the device, switch off the circuit breaker of the unit's power supply.
- Installation, service or repair must be performed by qualified technician.
- When the device is not intended to be used for a longer time, we recommend switching the circuit breaker of the unit's power supply off.
- Compressor unit must be installed in vertical position. Ceiling unit must be leveled to avoid condensate water to enter electrical part of the unit.
- It is forbidden to install the unit close to devices that may cause electrical or frequency disturbance such as welding machines, motors or rotors, WIFI/WLAN routers or repeaters.
- It is forbidden to alter electrical installation of the device. It is also forbidden to alter any other part or functionality of the device.

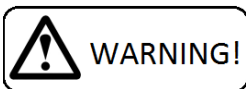

3.2 USAGE PRECAUTIONS

- Please read the entire User's and Installation Manual prior you proceed with installation or usage of this product. Do not continue or proceed if you have doubts, uncertainty or not full clarity about any step(s) described in this User's and Installation Manual.
- Do not cover or block the intake or exhaust openings. It is forbidden to block or cover the intake or exhaust openings with clothes, towels, buckets, canoes, ceiling beams, etc.
- **Do not install or place any heating appliances close to intake grilles / louvers. It could continually overheat the dehumidifier and result in its malfunction or damage.**
- Do not climb up on or sit on the unit.
- Do not place any objects on the top of the unit (e.g. boxes, flower vases, etc.).
- Do not hang any objects on the unit.
- Do not spray any flammable substances into the equipment; this might lead to fire.
- Do not clean the equipment with aggressive cleaning agents; this might lead to damage or deformations.
- When cleaning plastic parts do not use any cleaning agents unsuitable for the cover of the dehumidifier (household cleaning agents, solvents, bleaching agents, benzene, diluents, rough cleaning powder, cresol, chemical agents). Instead, sweep the dehumidifier cover with a soft cloth or a sponge.
- Never throw or insert any objects into any hose or opening.
- The cover of ceiling unit is made from acryl. The cover of compressor unit is made from powder coated metal. Do not manipulate with lighted cigarette, cigarette ashes, or any other kind of fire in vicinity to this part.
- Use this device exclusively for the intended purpose, as described in the attached instruction manual. Do not use parts which are not recommended.
- Do not drink or use the condensate water drained from the unit. Do not return the water back to the swimming pool. The water may be contaminated with bacteria.
- Children are not allowed to operate, touch or play with the unit.
- **Children are not allowed to manipulate with packaging, plastic / bubble foil. Risk of suffocation!**
- **Prevent the children from injury or harm caused by any manipulation with the unit, its parts or its packaging. Small parts like screws may be swallowed and cause suffocation or harm to health.**
- Do not leave the children in the swimming pool hall unattended.
- The dehumidifier should be sized correctly and run max. 18 hours a day, optimum max. 12 hours a day. In the case it runs more than 18 hours a day in long term it may fail, malfunction or get damaged. Warranty does not cover such damages as the machine is considered undersized if running longer than 18 hours a day.

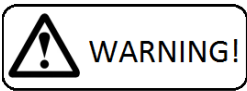

3.3 HANDLING PRECAUTIONS

- *Leave the compressor unit in vertical upright position for at least 2 hours before the installation. This will level the oil inside the compressor.*
- *Transport of the compressor unit in lying position or turning the compressor unit over may harm the compressor and will lead to loss of warranty.*
- *The device must be handled with care and special attention avoiding any mechanical damage.*
- *It is forbidden to apply any improper mechanical force onto the unit. This may cause mechanical damage to the device.*
- *It is forbidden to let the device fall freely onto the ground or any solid surface resulting in hard impact.*
- *Please notify your reseller or distributor if you suspect that the unit was delivered damaged. Unit may seem to work well at start but small damage can make the unit go out-of-order in short time. In such case the unit must be inspected and approved for further use by your reseller.*
- *Please notify your reseller or distributor if directly after installation you suspect that unit is not working in perfect order.*
- *In the case of device failure resulting from improper handling or mechanical damage (impact, hit, fall, etc.), the manufacturer reserves the right to evaluate the continuity of warranty.*



4. PARTS LIST

The unit was delivered in 2 boxes on a wooden palette(s). After you unpack the boxes, please check the content. It should include the following:

Name/Code	Picture	Name/Code	Picture
1 - Ceiling unit 1x		2 - Compressor unit 1x	
3 - Wall console for compressor unit 1 set (on demand)		4 - User's Manual 1x	
5 - F8 fastener 4x		6 - ML1 D8 fixation double nut 4x	
7 - MX8 hex nut d8 8x 12x if installation on wooden beam		8 - TR8 threaded bar M8x1000mm 2x	
9 - MB8 flat washer 8x 12x if installation on wooden beam, additional washers may be supplied MX10		10 - Scheme diagram 1x	

<p>11 - Three core cable with markings 123 (mono), 123 (due) 1x</p>		<p>12 - Three core cable with markings L1,N1,Earth 1x</p>	
<p>13 - - Back lift assembly (1) with anchor 1x</p>		<p>14 - Bluetooth receiver speaker cable (only DRY SIREN due)</p>	
<p>15 - Rope 14.5m 1x</p>		<p>16 - Front lift assembly with locking mechanism (2) with anchor 1x</p>	



The pictures and drawings in Parts list may differ from those actually delivered. Some parts may have been delivered upper hand and are thus not included in this shipment. If you are unable to locate all parts or are unsure if the supplied parts are complete, please contact your distributor.



Please note that the screws and dowels supplied with this dehumidifier are to be used only with solid concrete. Please check your ceiling material and choose appropriate screw and dowel.



CEILING UNIT

1. Main cover
2. Air intake
3. Air outake
4. LED lamp + microLIGHT+
5. Bluetooth speaker
6. Auto dimmable light sensor
7. Refrigerant connection Suction (1)
8. Refrigerant connection Discharge (2)
9. Electrical connection – L1, N1, Earth, 123
10. Lifting mechanism
11. Fixation hooks and Fixation ropes
12. Condensate drain
13. Serial number plate
14. Mains cable connector
15. Communication cable connector
16. Reprodutor cable connector (dry siren due only)
17. Main control unit
18. Bluetooth box
19. Condensate drain pump

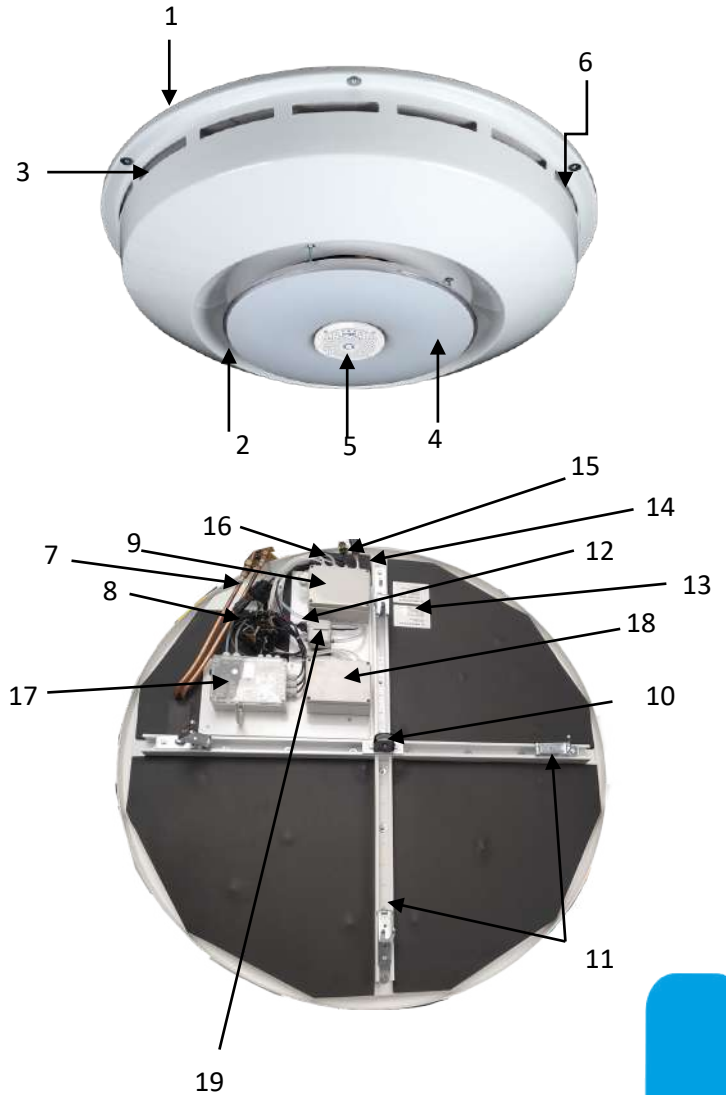

COMPRESSOR UNIT

1. Silent blocks
2. Refrigerant connection Suction (Master)
3. Refrigerant connection Discharge (Master)
4. Refrigerant connection Suction (Slave or mono)
5. Refrigerant connection Discharge (Slave or mono)
6. Communication cable to ceiling unit – 123 (Master)
7. Communication cable to ceiling unit – 123 (Slave)
8. Ceiling unit power supply – L1, N1, Earth (Master)
9. Ceiling unit power supply – L1, N1, Earth (Slave)
10. Refrigerant plate
11. Serial number plate
12. Main power supply – L, N, Earth
13. Terminal connection for main power supply (L, N, Earth) and ceiling unit power supply (L1, N1, Earth)
14. Terminal for connection of communication cable –123
15. Compressor
16. Main PCB

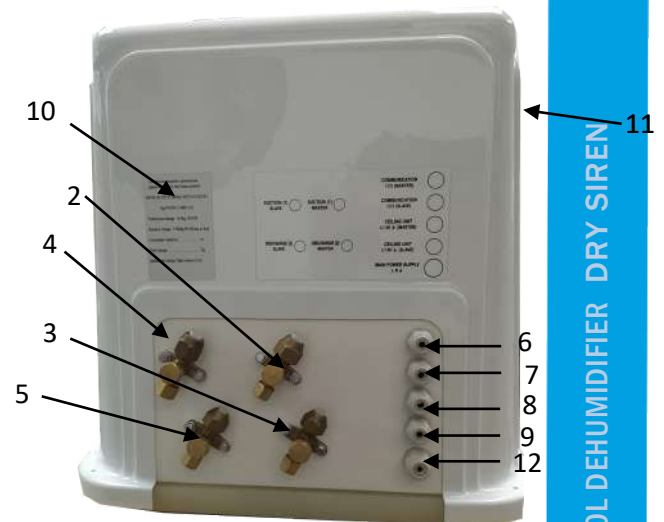

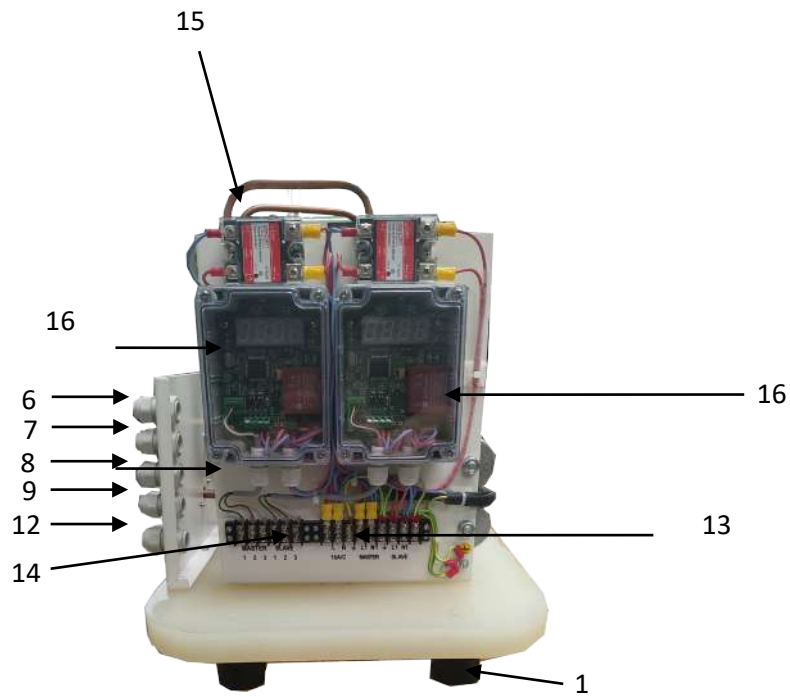

WIFI antennae position when receiving unit in package













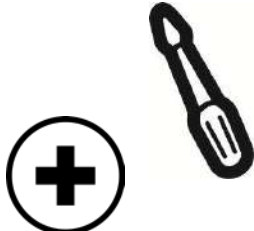
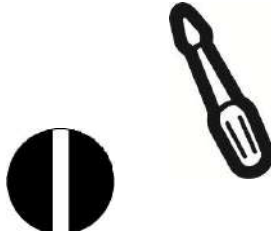

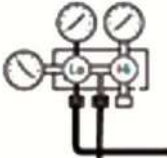

WIFI antennae position during use – please direct the WIFI antennae upwards to ensure signal quality

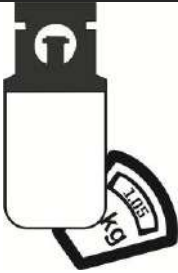
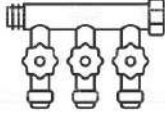

5. TOOL LIST

In order to perform the installation correctly, you will need following tools:

Name/Code	Picture	Name/Code	Picture
19 - Drill 1x		20 - Drill bit 10mm 1x If installation on a wooden beam: 9mm and 11mm drill bit	
21 - Screwdriver Phillips PH2 1x		22 - Screwdriver Slot 5/32 1x	
23 - Small hammer 1x		24 - Tape measure 1x	
25 - Spirit level 1x		26 - Combination wrench / open-end wrench - 2x13mm, 1x16mm, 1x17mm, 1x19mm, 1x22mm, 1x24mm or adjustable multiple	
27 - Charging and testing hoses with valve, 1/2" – 20UNF 2x		28 - Vacuum Pump 170l/min 1x	

<p>29 - Charging scales +/-2g 1x</p>		<p>30 - Manifold valve R410A</p>	
<p>31 - R410A Bottle 1x</p>		<p>32 - Flaring tool – tube 1/2, 3/8 1x</p>	
<p>33 - Cutter – tube 1/2, 3/8 1x</p>		<p>34 - Tube Bender – tube 1/2, 3/8</p>	
<p>35 – Saw for iron 1x</p>			

6. INSTALLATION – CEILING UNIT

Ceiling unit is designed for an installation at the ceiling or at lower ceiling. Typically the ceiling unit is fixed into the concreted structure of the upper floor or wooden roof. Please make sure that the material into which the ceiling unit is to be fixed is suitable for such installation. Manufacturer is not responsible for damages or losses caused by an incorrect installation or inappropriate concrete or wood type. Ideally it should be installed above the evaporation source. It should be installed on easy accessible spot to allow maintenance and service.

Please view following **concrete types and strengths**.

Pressure class	$f_{ck,cyl}$ (MPa)	$f_{ck,cube}$ (MPa)	Appropriate	Threaded bar TR8 L1 drill depth	Anchor for lifting mechanism
C8/10	8	10	No	N/A	N/A
C12/15	12	15	No	N/A	N/A
C16/20	16	20	Yes	80mm	60mm
C20/25	20	25	Yes	60mm	60mm
C25/30 and more	25 and more	30 and more	Yes	40mm	60mm

Concrete marking with additional request for seepage resistance: STN EN 206-1 –C25/30-XF2,XC2 (SK) – CI 0,4 – Dmax 16 – S3, seepage 50mm according to STN EN 12390-8.

6.1 BASIC MANIPULATION

The unit is designed to be located on the ceiling. We, at Microwell, had to ensure a perfect balance between weight and long-term durability with focus on reliability of the product. It is thus necessary to mind below manipulation information and comply with them. Non-compliance may lead to product damage, malfunction or failure. Manufacturer is not responsible for incorrect manipulation or for manipulation not compliant to this User's manual.

Ceiling unit is delivered in a box with polystyrene support from the bottom at sides.

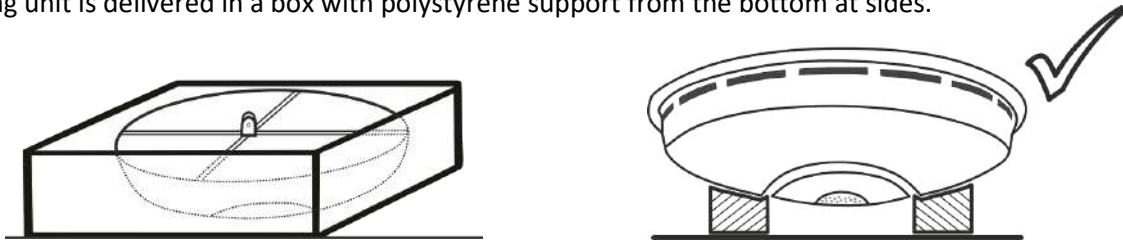

Do not place ceiling unit on side. The unit is not designed to stand on its side. Main cover damage may occur in such position.



Do not place ceiling unit on the ground. Do not put the unit on an object or support holding the unit in the center.

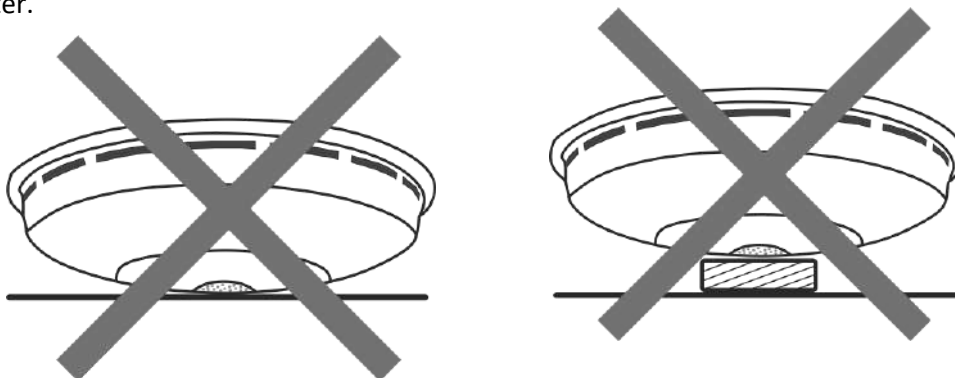

Do not place any objects such as drill tools, boxes, vacuum cleaners, etc. on the top of the ceiling unit.

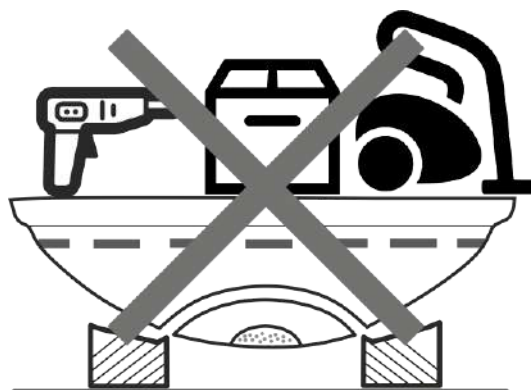

Do not hold ceiling in areas where forbidden (bluetooth speaker, LED lamp, air outlet). For manipulation hold the unit on the side which is supported by metal structure. Do not hold in places where plastic cover does not have metal support.

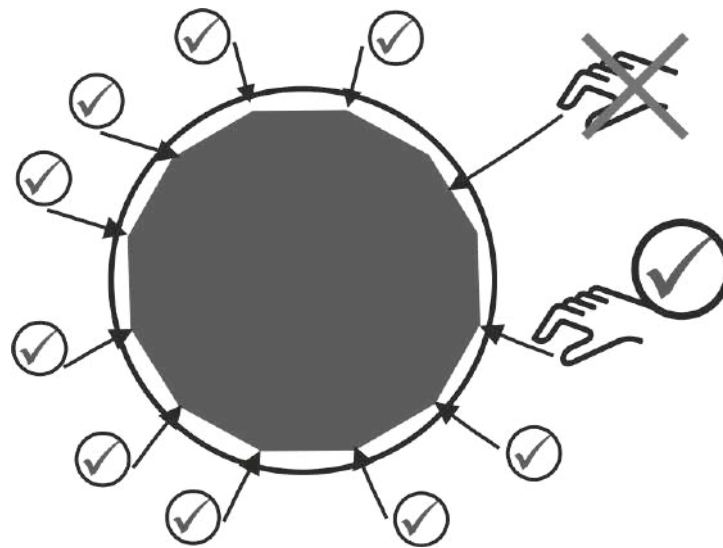
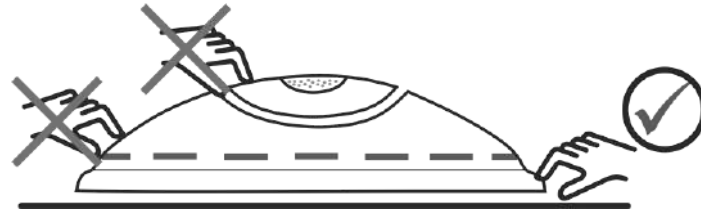

DO NOT INSTALL THE CEILING UNIT IN BETWEEN THE WOODEN BEAMS OR SIMILAR OBJECTS. Air flow on the outlet will be reflected from the object (wooden beam) and redirected back to the unit. Thus the water collection process will be dramatically reduced and the unit will be exposed to the risk of overheating.

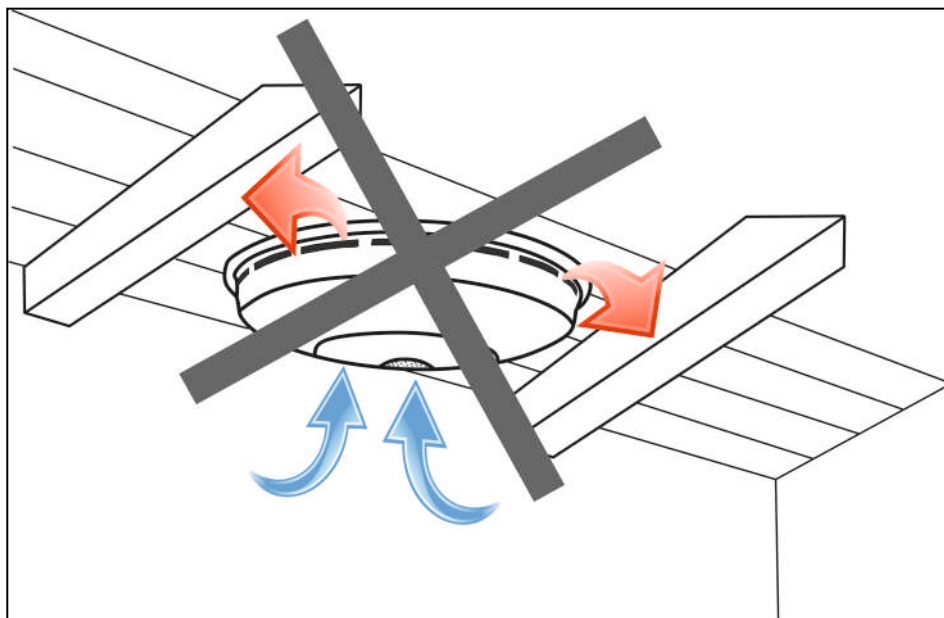

6.2 APPROPRIATE POSITION OF CEILING UNIT

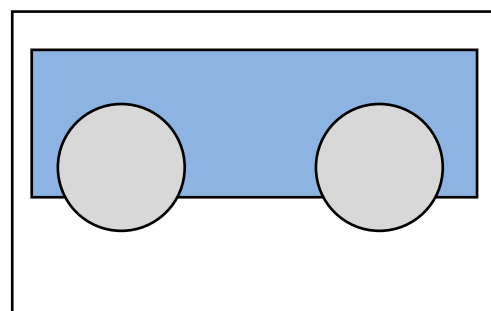
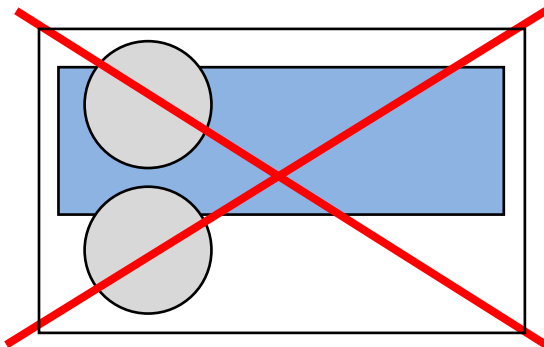
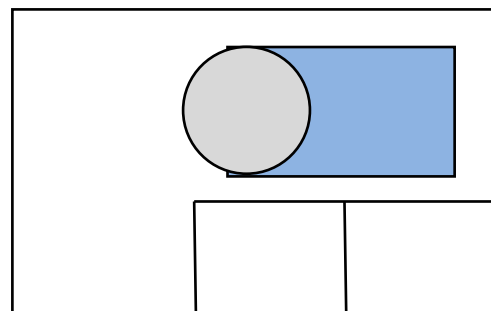
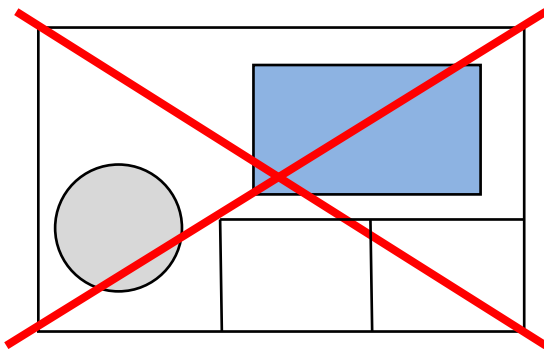
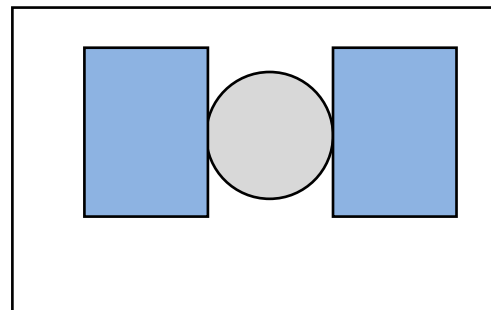
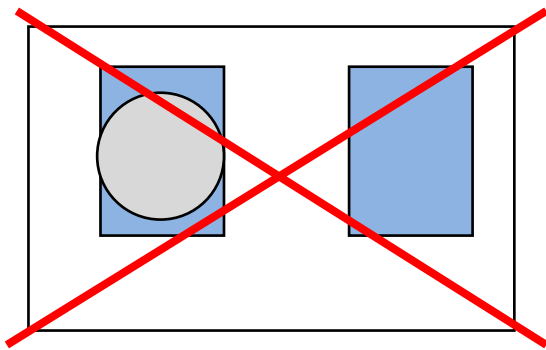
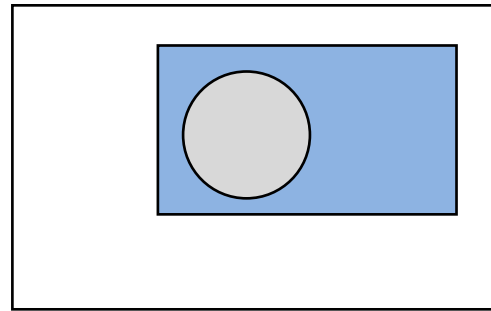
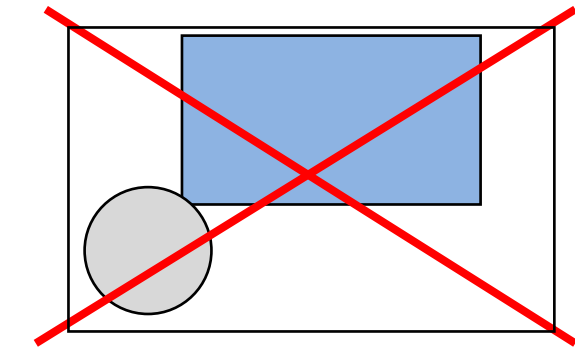

Please mind electrical safety requirement below to locate an electrical device close to pool water.

ZONE 1, IPX4

Swimming pools which are not cleaned by jet water

in the distance of 1250 to 2000 mm from the swimming pool edge, the unit must adhere to the HD, IEC standard and in the height of at least 300 mm from the floor

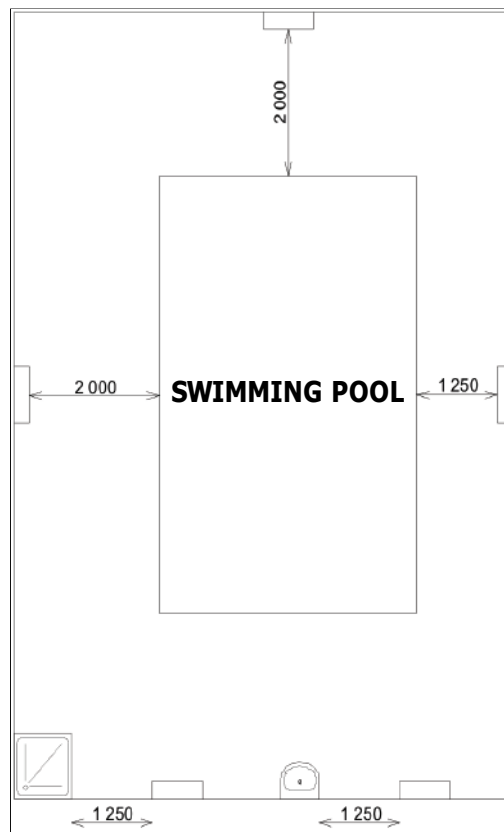

ZONE 2, IPX2

Swimming pools which are not cleaned by jet water

In the distance of 2000 to 3500 mm from the swimming pool edge, the unit must adhere to the HD, IEC standard and a minimum 150 mm elevation above the ground is required for sufficient air flow. Installing the unit on the floor is prohibited.

OUTSIDE THE ZONES

In the distance of 1250 mm or less from the swimming pool edge, the bottom edge of the unit must be in the height of 2500 mm from the swimming pool surface; if it is embedded under the floor, then 2500 mm from the floor.

At least 1250 mm (i.e. out of the reach of the hand) from the lateral edge of the shower cabinet. It cannot be placed above the shower cabinet.

At least 1250 mm (i.e. out of the reach of the hand) from the lateral edge of the wash basin, in the minimum height of 1200 mm above ground. It cannot be placed above the wash basin.

OUTSIDE THE ZONES

In the distance of at least 1500 mm from the vertical plane around the jumping platforms, diving boards and 2500 mm above the highest surface, where persons are likely to stay.

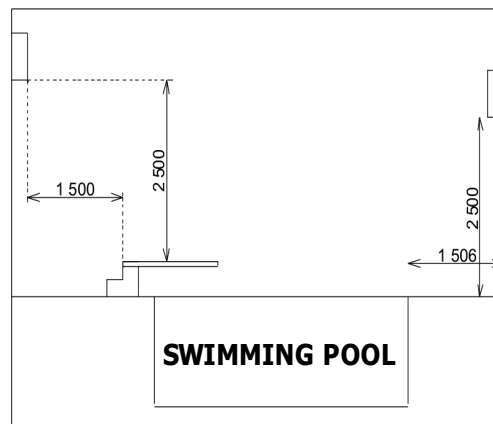

OUTSIDE THE ZONES

If the unit is in the distance of less or equal to 1250 mm horizontally from the edge of the swimming pool, then it must be raised up to the height of 2500 mm from the swimming pool surface; if the pool is embedded under the floor, then the unit must be raised up to the height of 2500 mm from the floor.

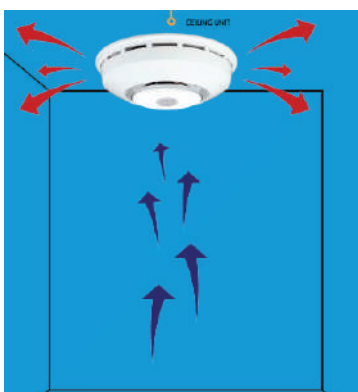

6.3 FIXATION ON A CEILING - CONCRETE / WOOD

1. Locate appropriate location for the ceiling unit.

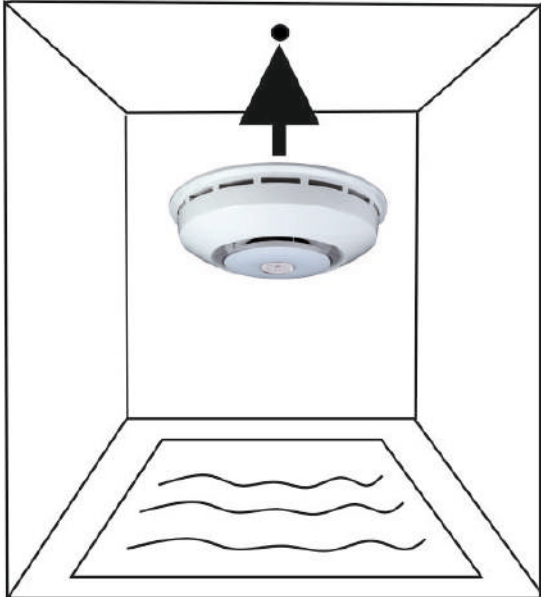

2. Mark the drilling holes according to Scheme diagram (Part number 10). Position the drill hole for lifting mechanism 800mm from the center in between the 2 threaded bars (TR8 – part number 8)

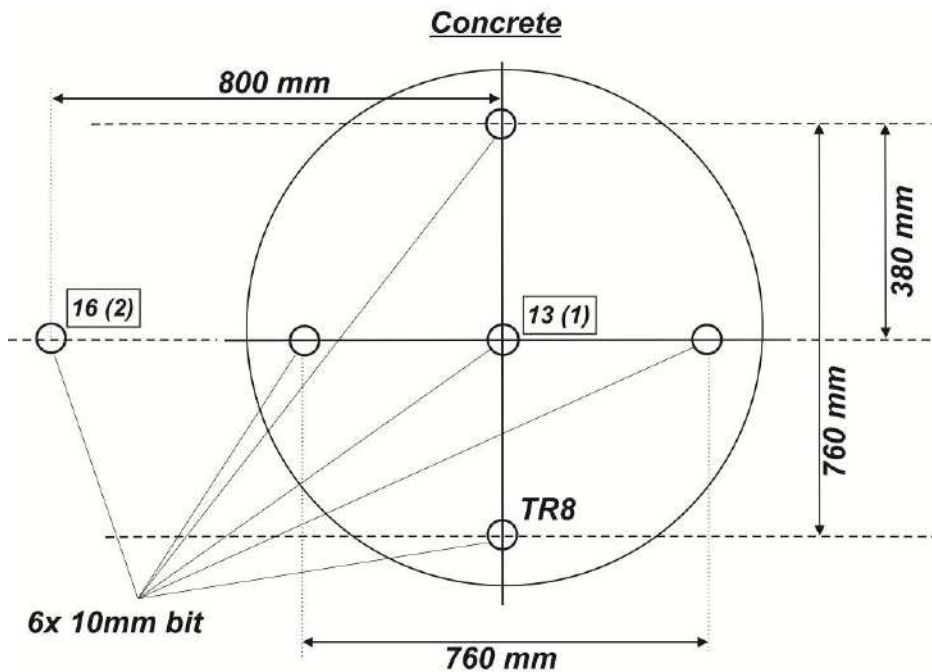
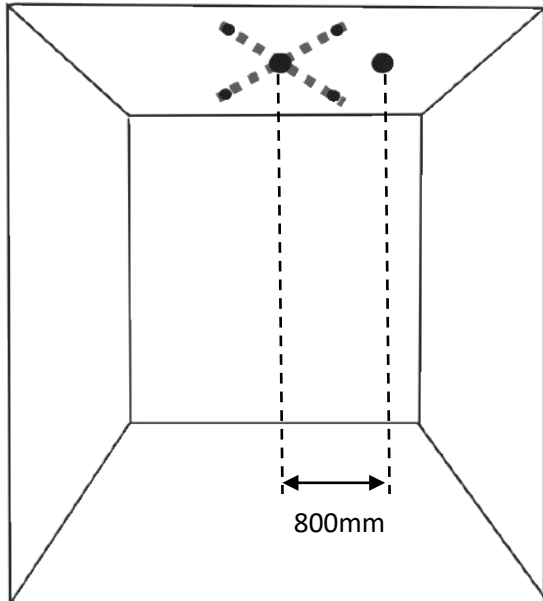

Wood beam

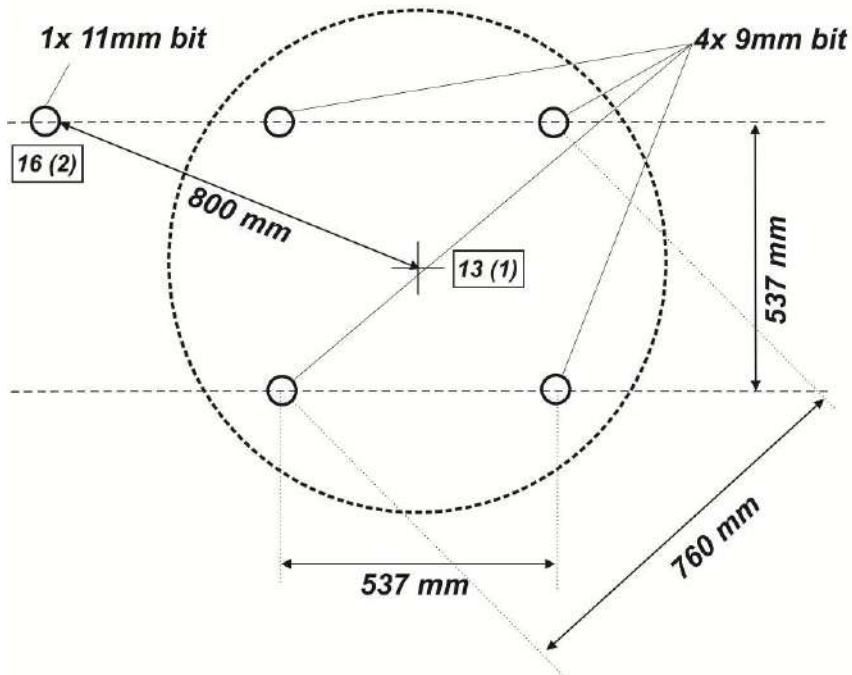

3a. Drill 6 holes (4 for TR8, 2 for Lifting mechanism).
/We advise to use vacuum cleaner simultaneously when drilling to avoid dust and particles be spread into entire room./

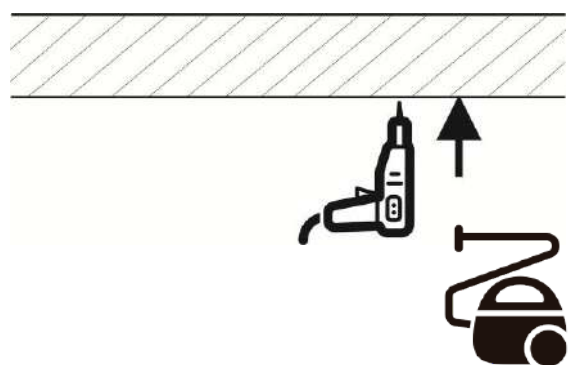
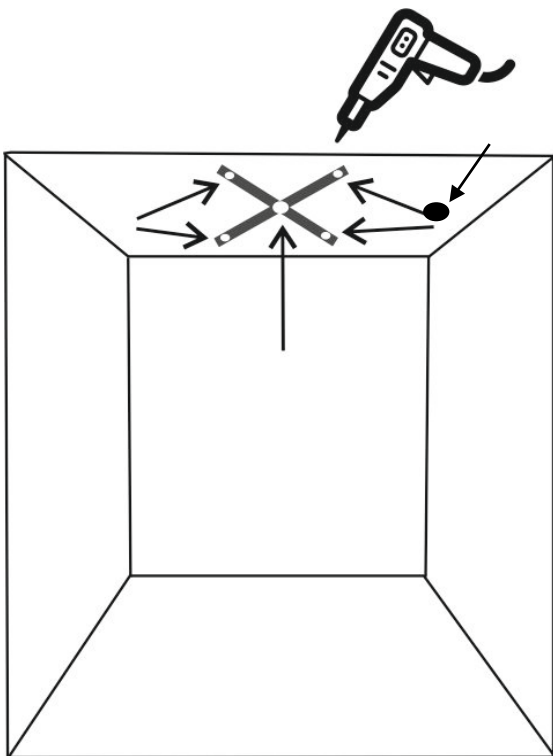

3b. Drill 4 holes (TR8) using 10mm bit by concrete and 9mm bit by wood beam. Drill 2 holes (Lifting mechanism – Part number 13 and 16). Please refer to needed drilling depth – section 6 INSTALLATION – CEILING UNIT – table Concrete types and strength. For wood we advise to drill completely through. Please mind that wooden beam must be statically resistant to hold weight of DRY SIREN unit (53kg) and it must be possible to drill 9mm hole through it without changing the static conditions of the wooden beam

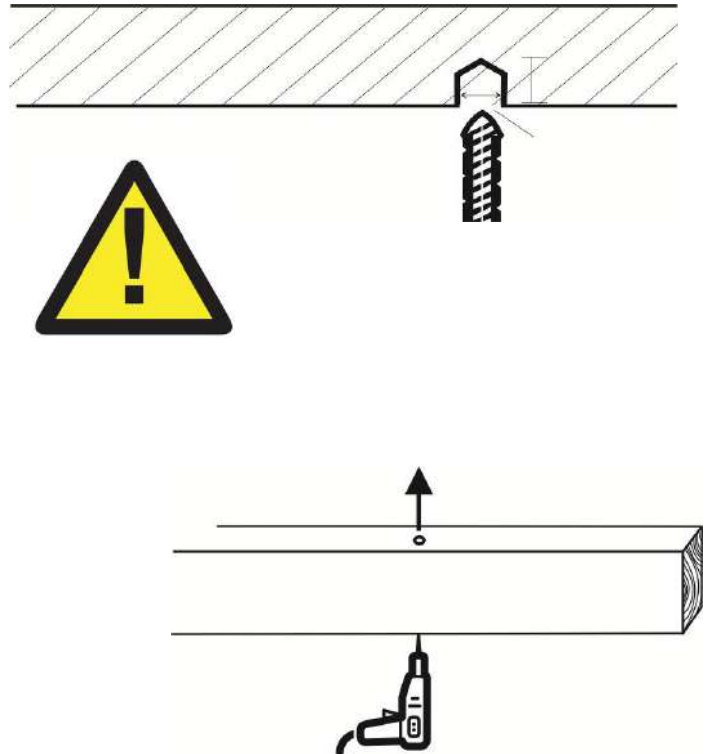
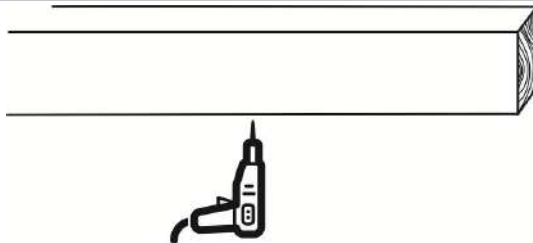

4. By concrete insert 4 fasteners into the holes for threaded bars. Fastener is part number 5. Use small hammer or appropriate.

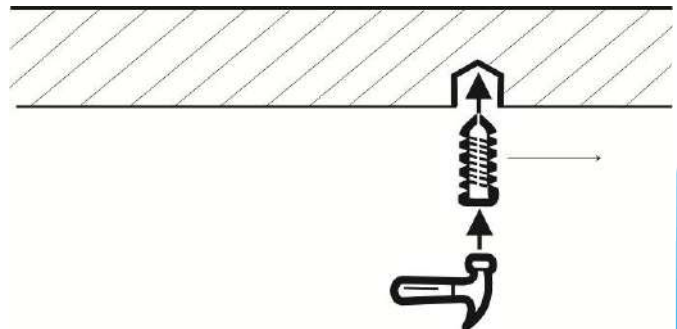

5. Assemble 4 mounting threaded bars for ceiling unit fixation. Use part numbers 5, 6, 7, 8, and 9. Please refer to picture below.

CONCRETE

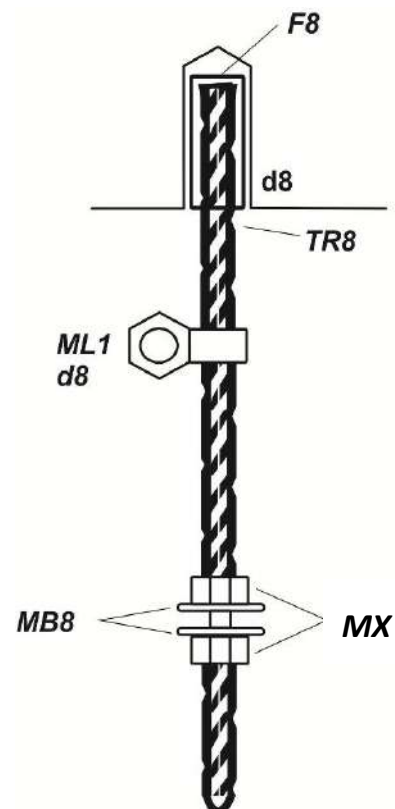

WOOD

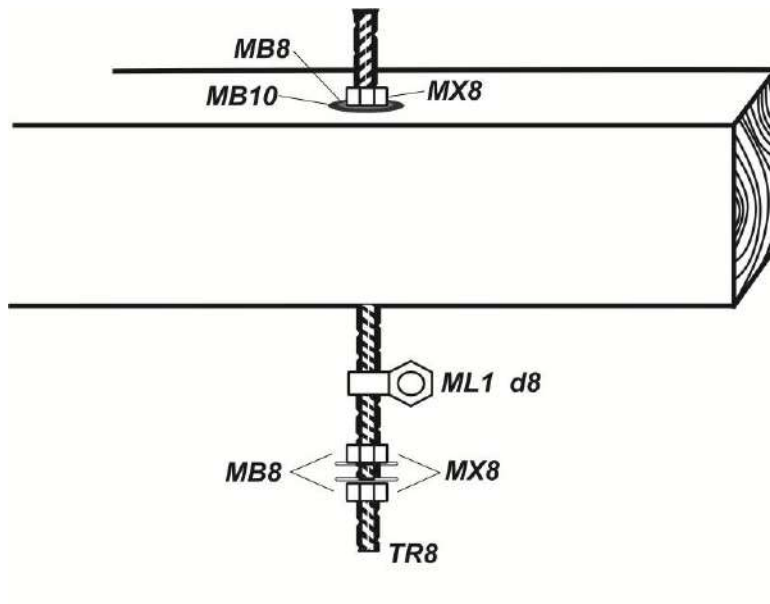

6. Please refer to picture below in order to fix the final length of threaded bars.

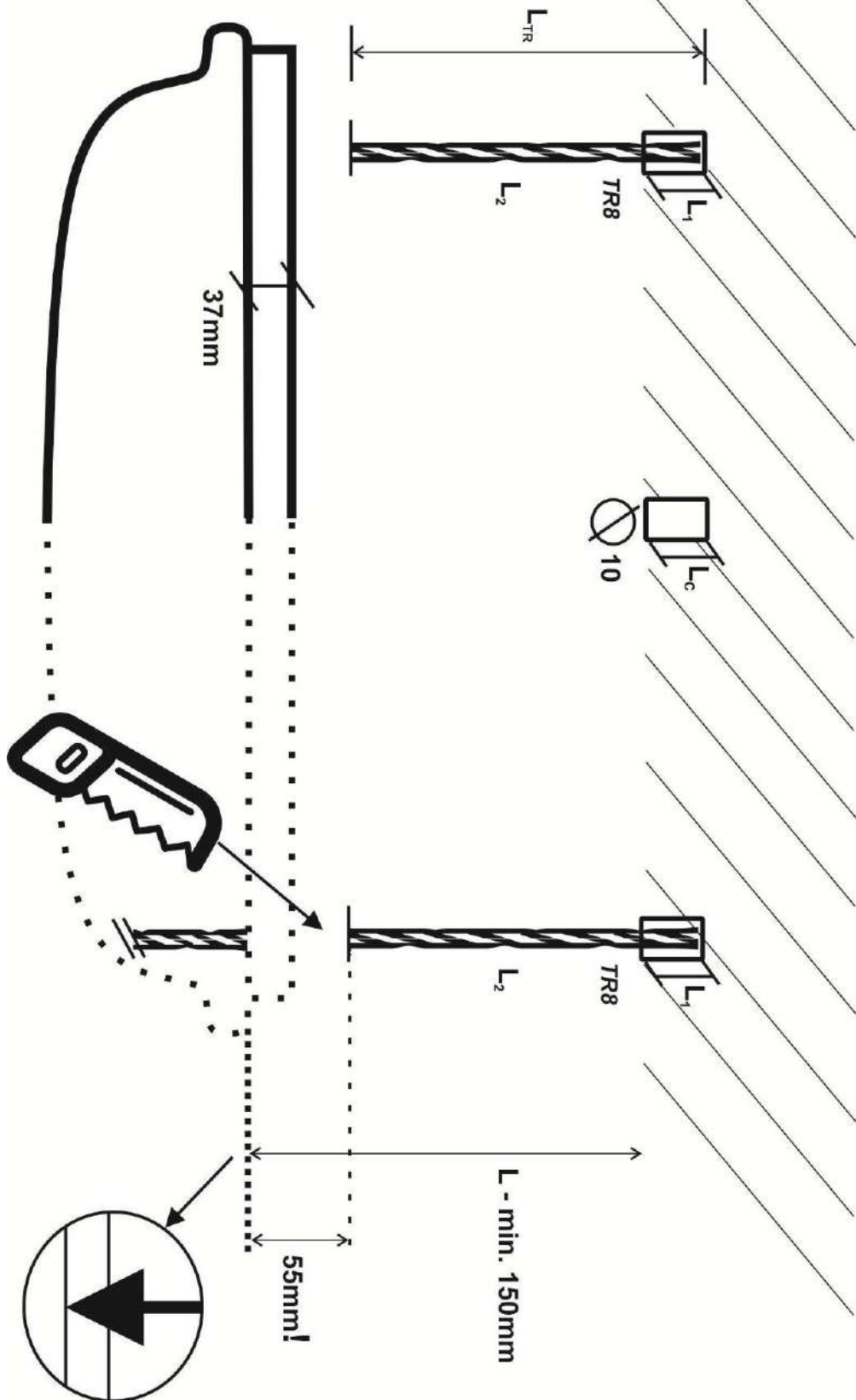

CONCRETE

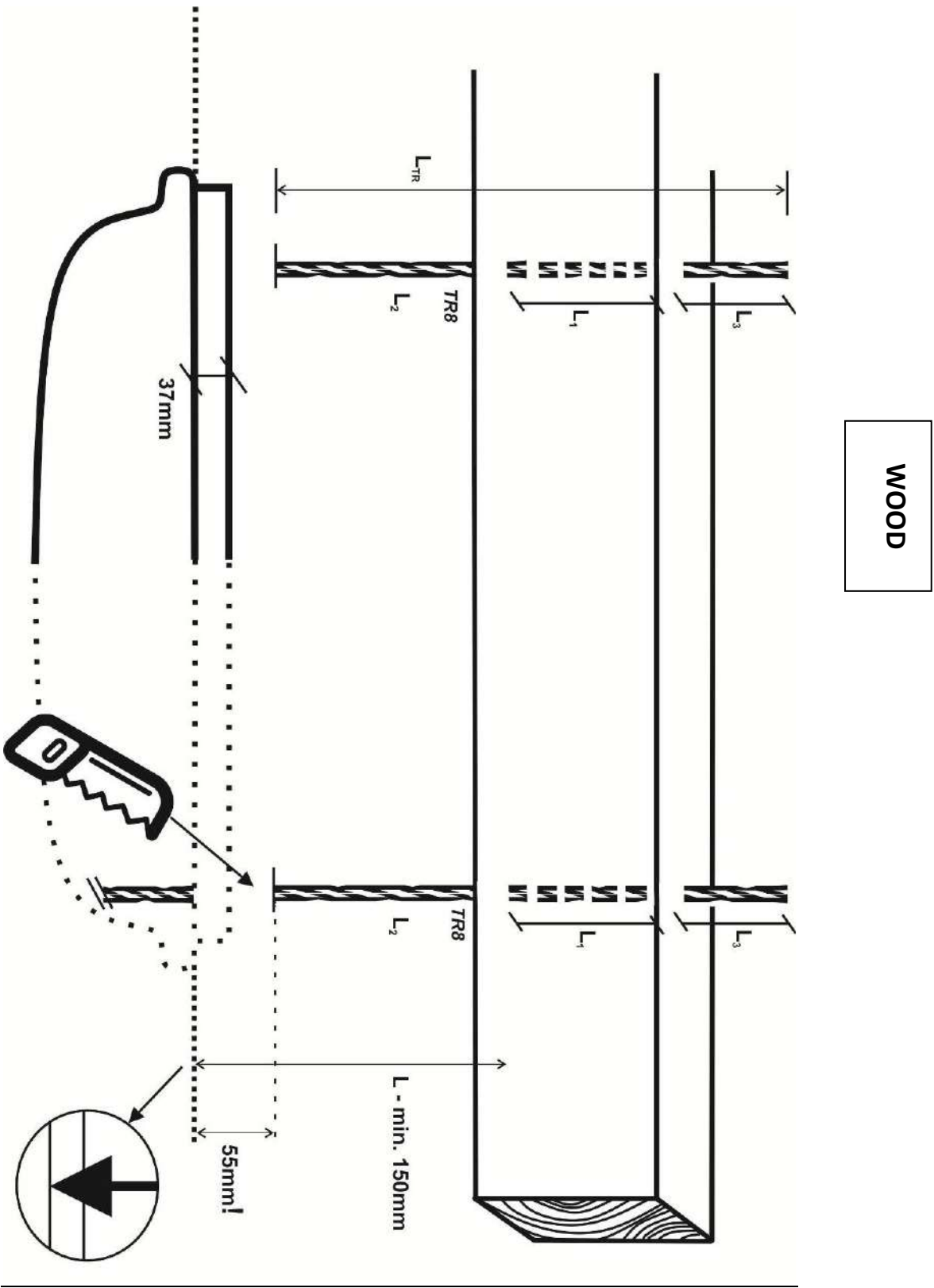

Example:

$$L_{TR} = L_1 + L_2$$

L_1 = depth in concrete of TR8 – please refer to section 6 INSTALLATION – CEILING UNIT or height of the wooden beam

L_C = depth in concrete of lifting mechanism – please refer to section 6 INSTALLATION – CEILING UNIT

$$L_2 = L - 55\text{mm}$$

L_3 = distance above wooden beam. Due to security there is a minimum buffer 40mm.

Practical example CONCRETE:

Lower ceiling is 150mm below the main concrete. Concrete type is C25/30. (see **concrete types and strengths** in 6 INSTALLATION – CEILING UNIT).

$$L = 150\text{mm}$$

$$L_1 = 40\text{mm}$$

$$L_2 = 150 - 55\text{mm}; L_2 = 95\text{mm}$$

$$L_{TR} = L_1 + L_2; L_{TR} = 40 + 95 = 135\text{mm}$$

Maximum length of the 4 threaded bars is 135mm.

Practical example WOODEN BEAM:

Lower ceiling is 150mm below the main wooden beam. Wooden beam is 100x100mm.

$$L = 150\text{mm}$$

$$L_1 = 100\text{mm}$$

$$L_3 = 40\text{mm}$$

$$L_2 = 150 - 55\text{mm}; L_2 = 95\text{mm}$$

$$L_{TR} = L_1 + L_2 + L_3; L_{TR} = 100 + 95 + 40 = 235\text{mm}$$

Maximum length of the 4 threaded bars is 235mm.

7a. Lifting mechanism fixation. Please refer to part numbers 13 and 16

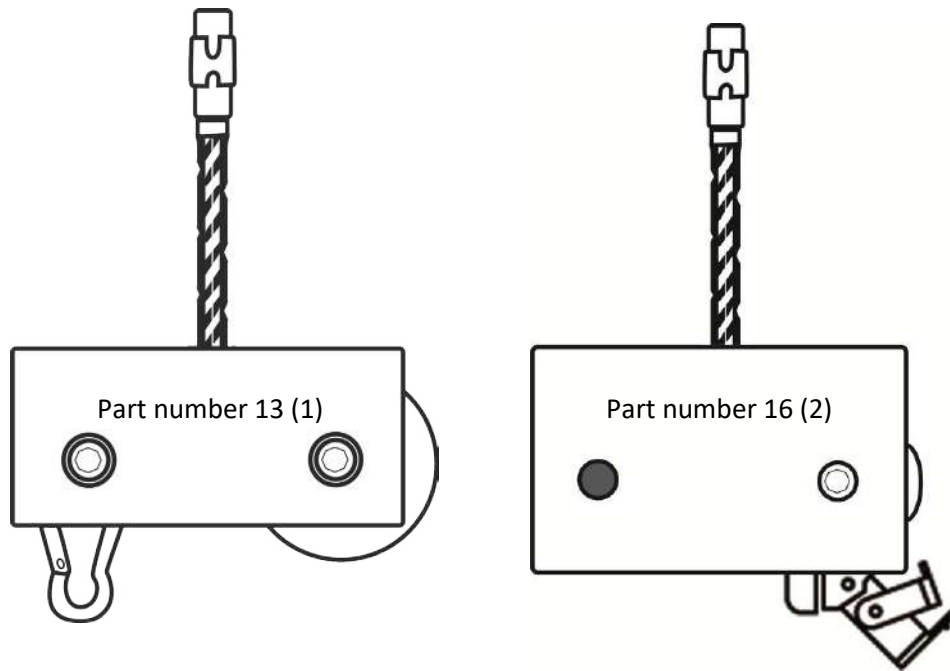

7b. Please mind the necessary depth in concrete (6 INSTALLATION – CEILING UNIT). Both parts are equipped with concrete anchors. These must be put inside the hole by force and then the respective nut inside the part must be tightened until the part is securely fixed into the concrete. PLEASE NOTE THAT BY WOODEN BEAM WE ADVISE TO FIX THE LIFTING MECHANISM COMPLETELY THROUGH THE WOODEN BEAM.

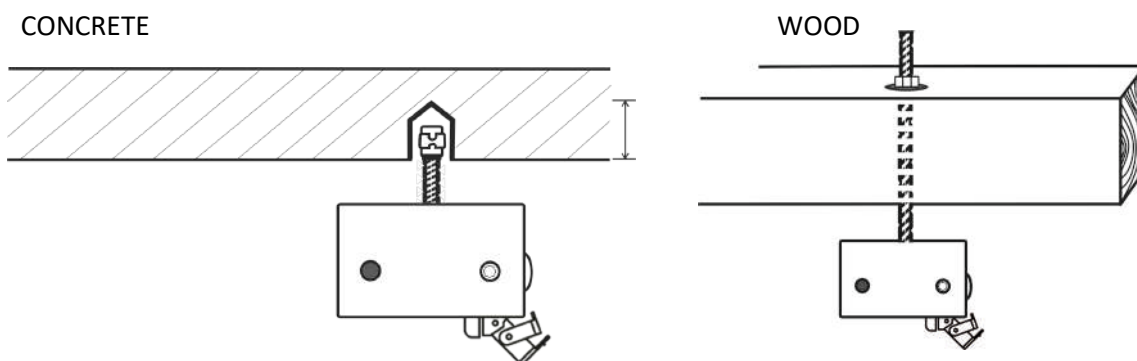

7c. Please mind the direction of part 13 and 16 as a rope will be used to lift the ceiling unit. Thus the direction of rope should be direct from Back lift assembly (part 13 -1) to Front lift assembly with locking mechanism (16-2). Please refer to picture below showing view from the top or bottom.

CONCRETE

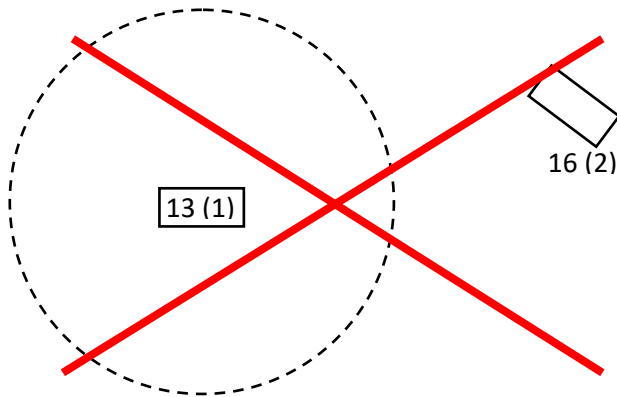
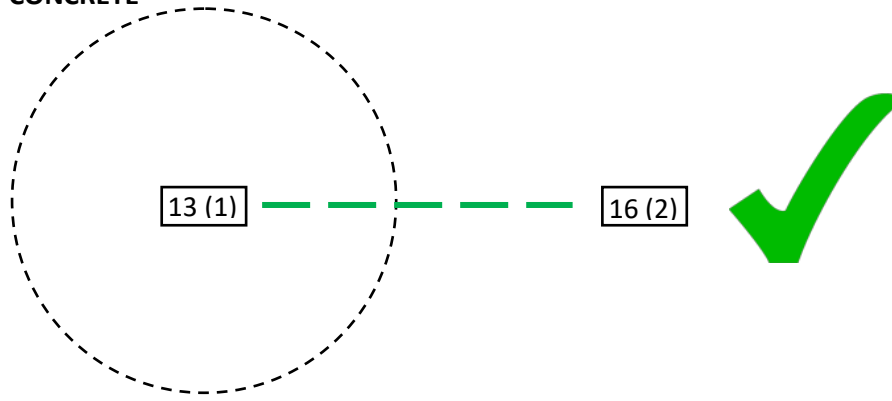

WOOD

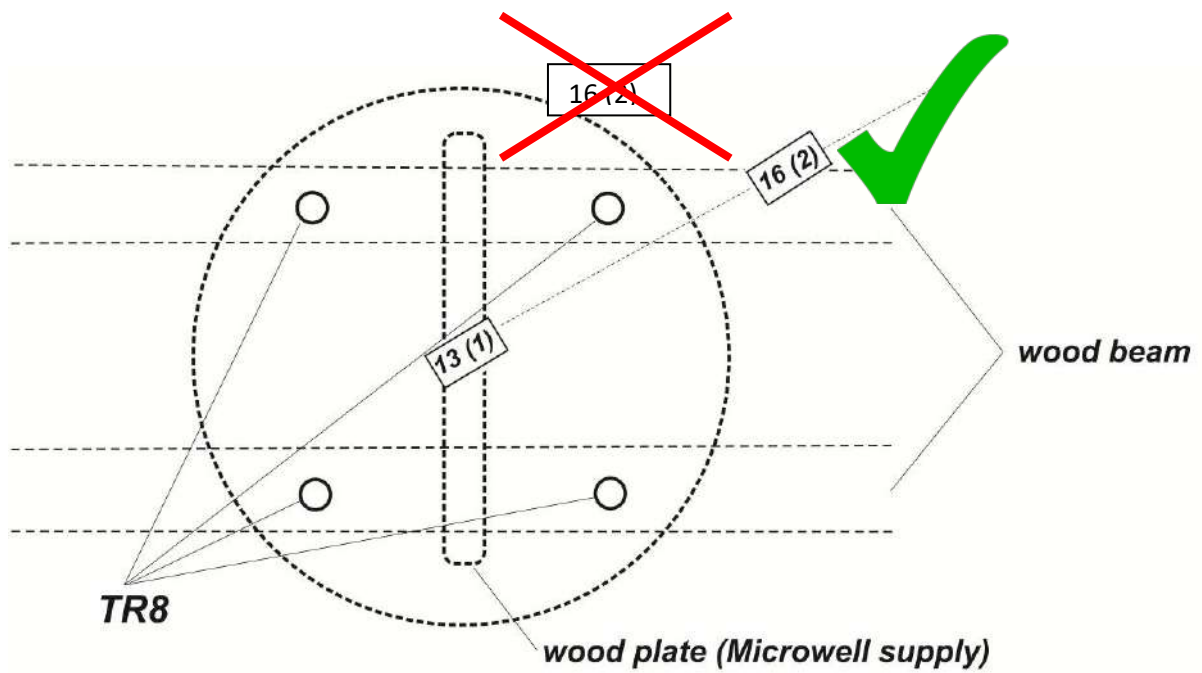

8. Bring the DRY SIREN box with ceiling unit in it under the spot where it will be installed. Take supplied rope (part number 15) and fix it step-by-step onto the lifting mechanism and DRY SIREN ceiling unit. Please take the hitch and fix it into the clip (1) of the Back lift assembly (part number 13). Untangle the rope and with the other end continue through the lifting mechanism of ceiling unit (2). Continue guiding the end of the rope through the wheel of Back lift assembly (3) out in direction of Front lift assembly (4). **Please make sure that the rope is correctly guided through the locking mechanism (5).** Pull the rope towards yourself until the rope is tight. Do not lift the ceiling unit yet. Rope is 14.5m long, you can thus use it for a maximum ceiling-to-floor distance of 4.5m.

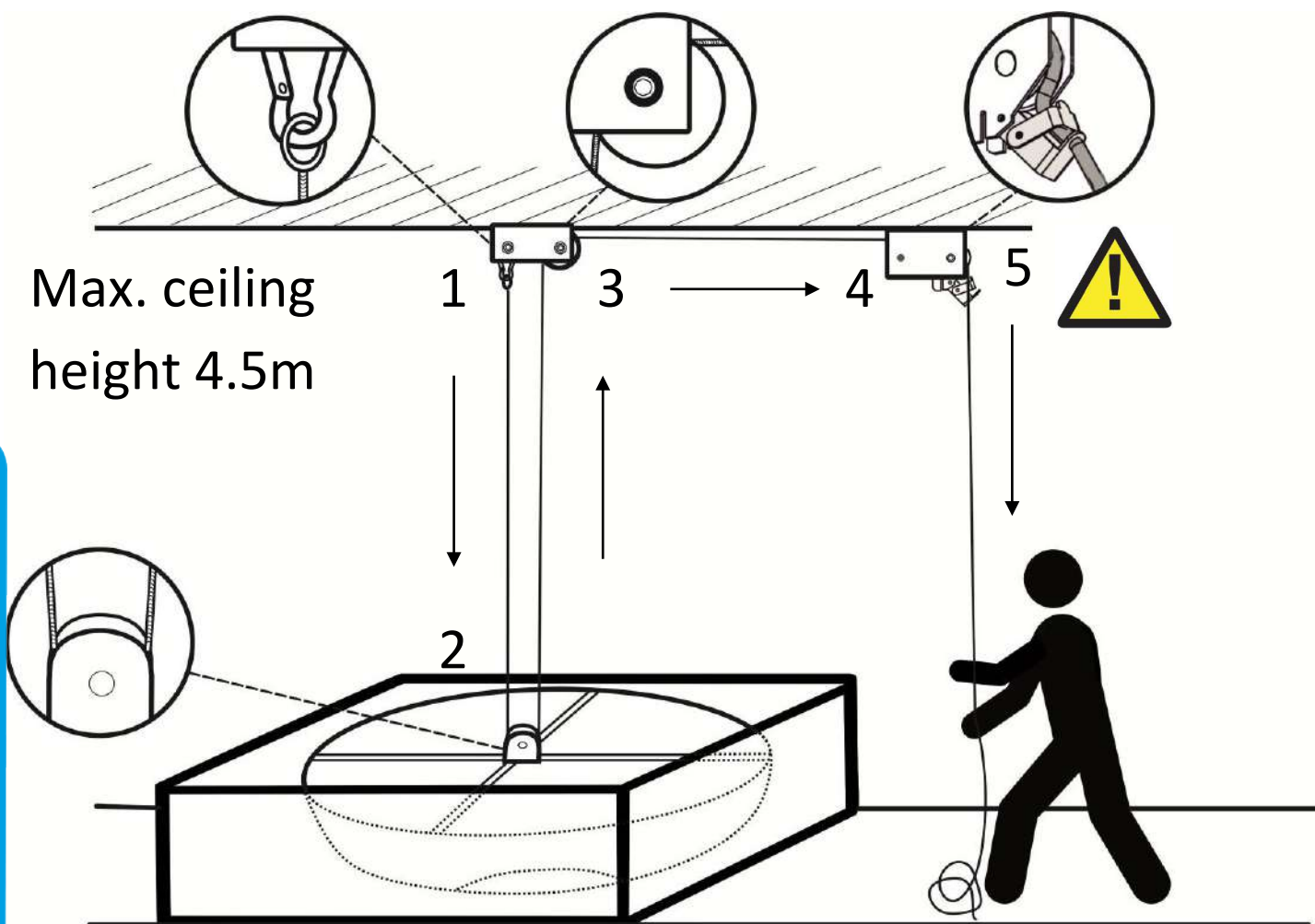

9a. Perform test of lifting mechanism. Please note that a force of 500N is required to pull the ceiling unit effectively up to the ceiling. A person performing the task must weigh minimum 70kg. A person with lower weight may be outweighed by the weight of the ceiling unit and accident may occur with result in person's injury and unit's damage.

10. Check the final distance of threaded bars and locking hooks on the ceiling unit. Should correction be needed, untight the hex screws and position to the correct position. Tight with hex screw.

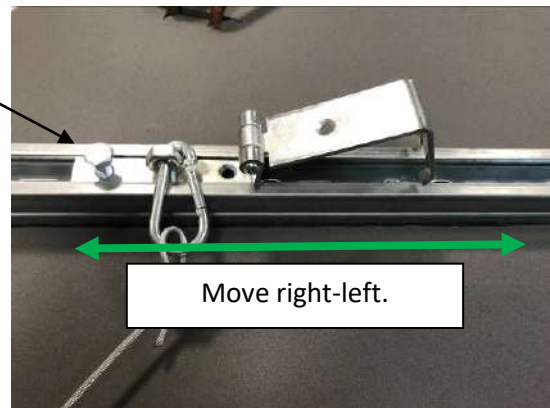
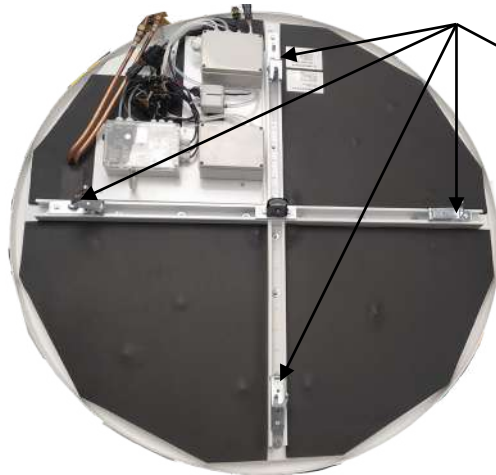

11. Test the functionality of locking mechanism. Please refer to picture below. Once you tested the tightness of lifting mechanism and locking mechanism you are ready to proceed to lifting the unit. This is designed as one man job.

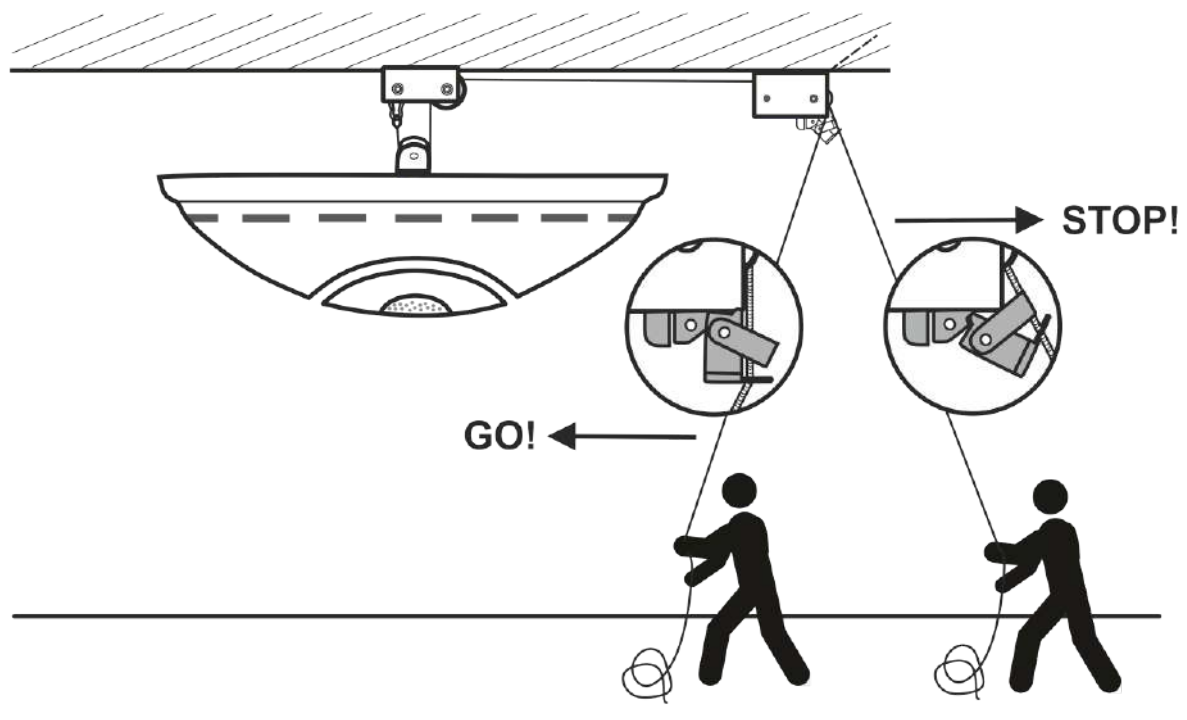

12. Next step will be actual fixation of the ceiling unit to its final position. **Please note this step and its process but do not lift or fix the unit yet as you need space to connect wires, refrigerant pipes and condensate drain.** You need to have the installation of other parts ready to proceed with following steps. Please fix the hooks onto the threaded bars 4x. Please fix the hooks with MX8 on each threaded bar. Secondly attach the steel rope clips onto the ML1 d8 to secure the ceiling unit 4x. Below picture shows fixed hook and steel rope clip on a threaded bar.

Unit must be perfectly levelled using spirit level! Uneven position may cause condensate drain leak and malfunction. Allowed tolerance is +/-0.3%.



CONCRETE

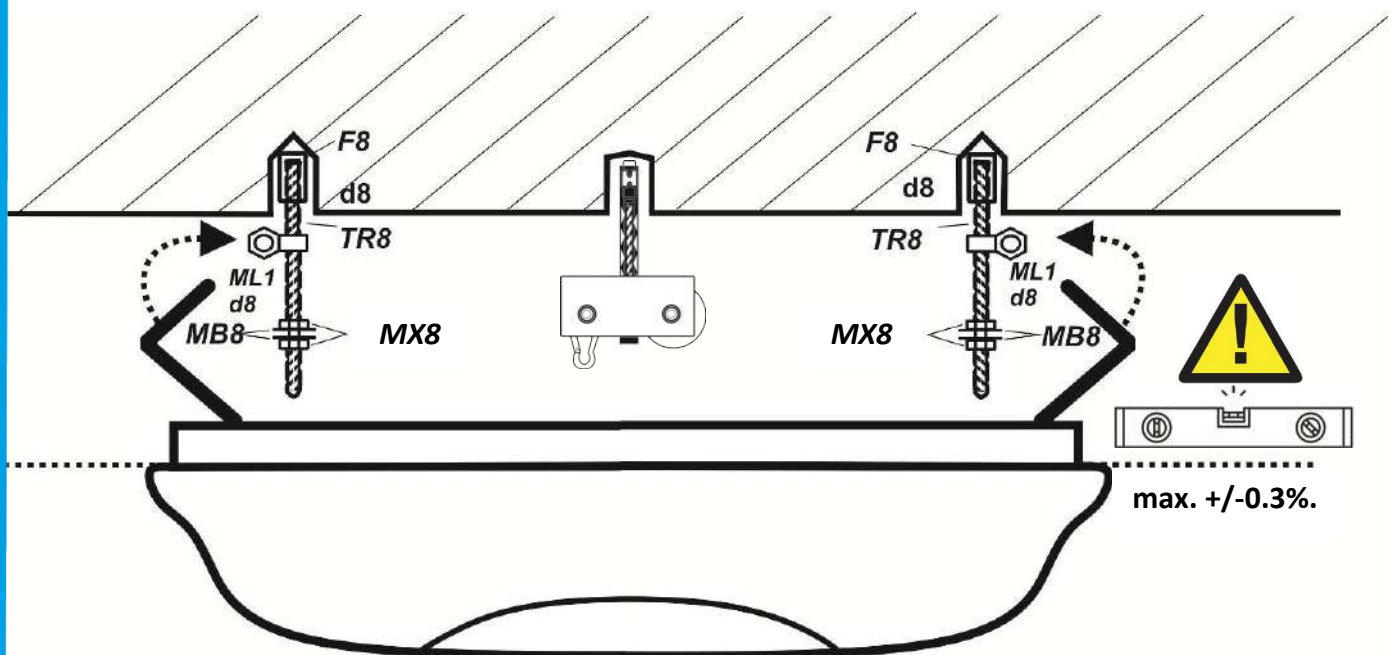

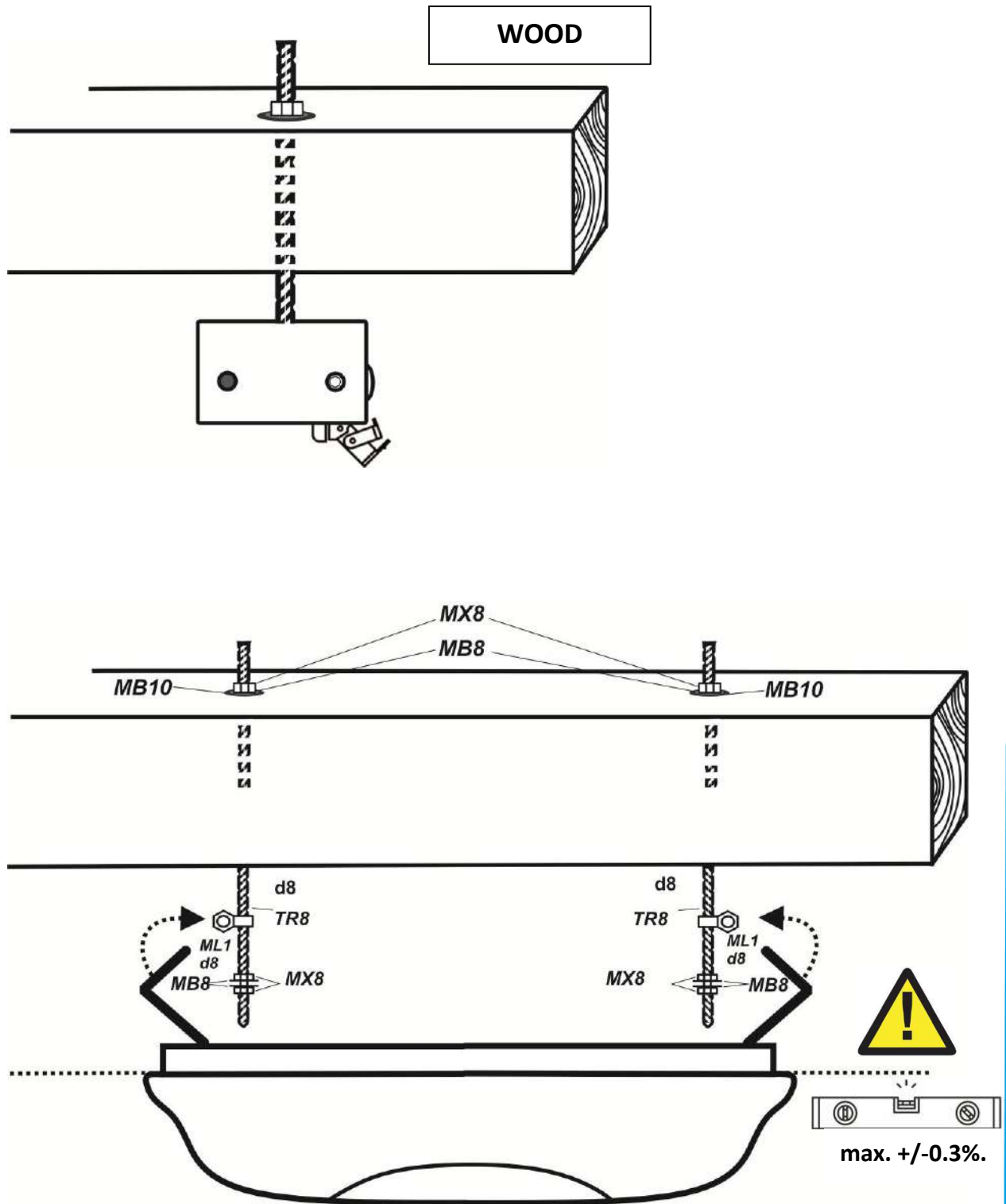

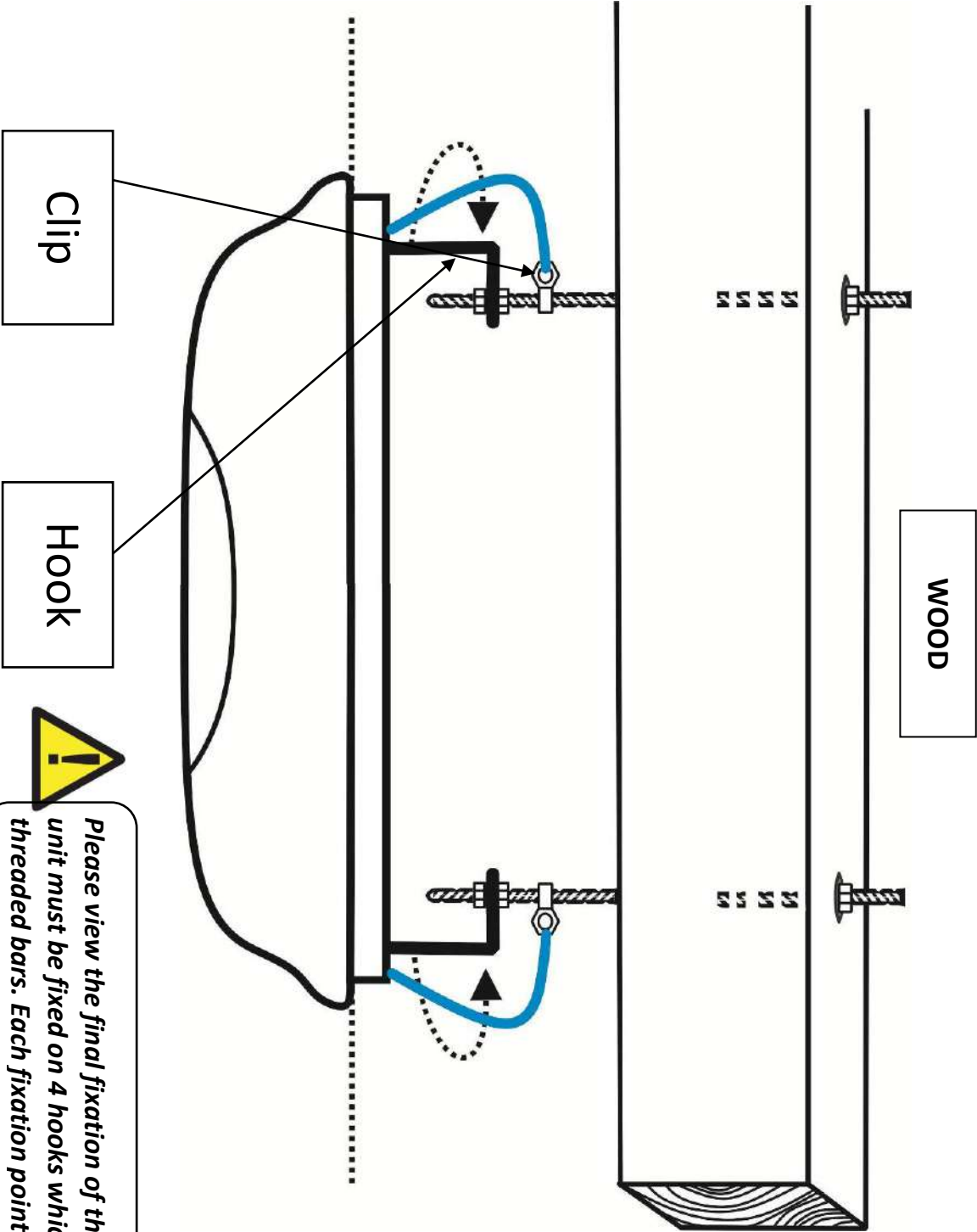

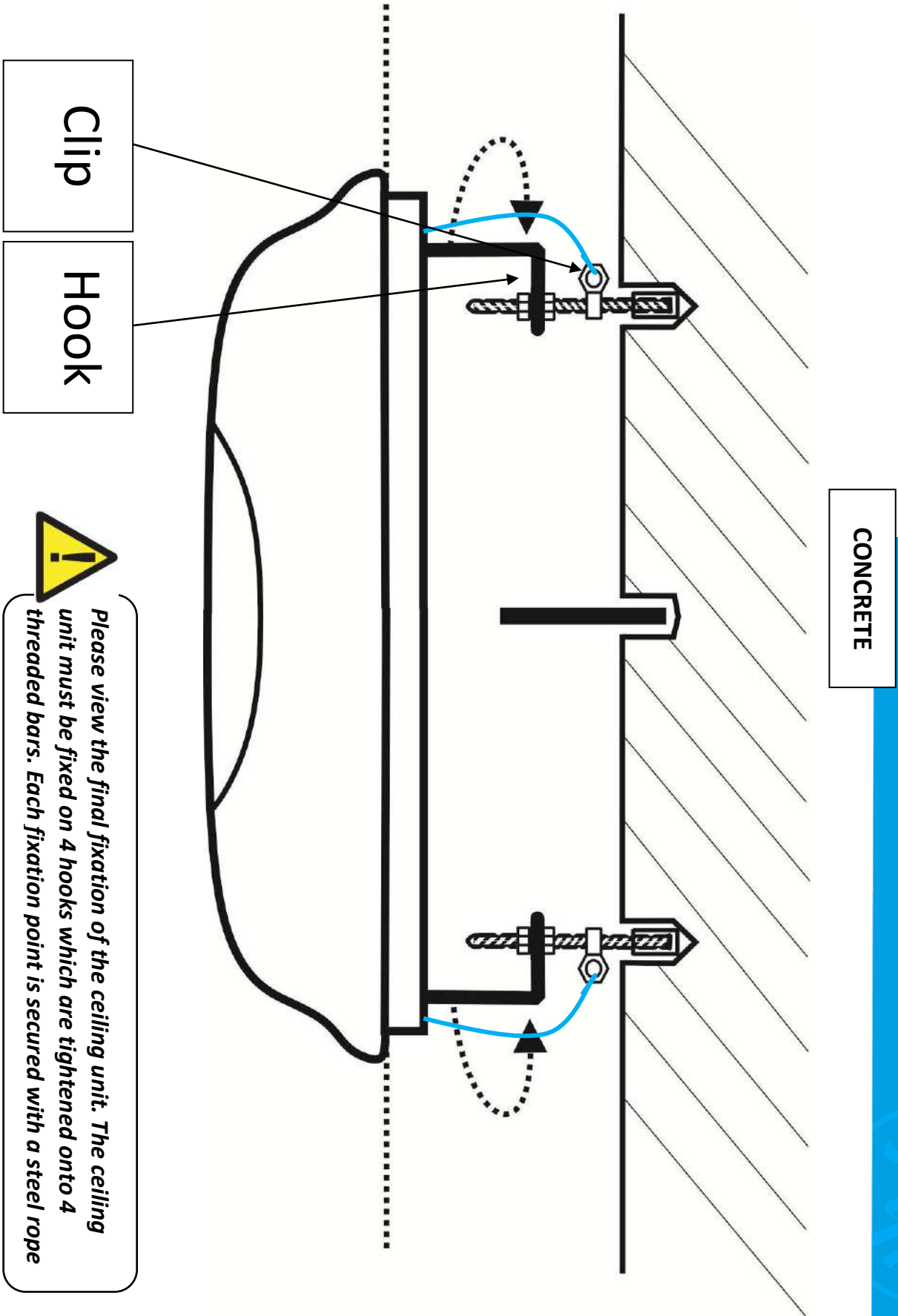



When installing you may use help of scaffold base or ladder. Mind all local work, health and safety requirements. Manufacturer is not responsible for injuries caused by inappropriate tools, equipment or work procedures.

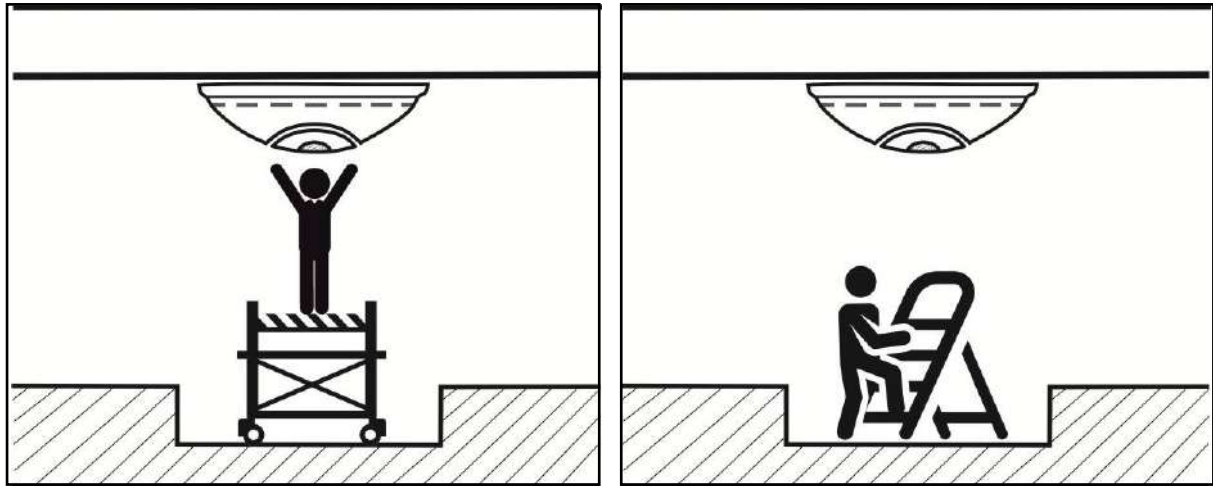

13. It is advised to construct 2 service hatches 400x400 next to DRY SIREN ceiling unit as per below drawing.

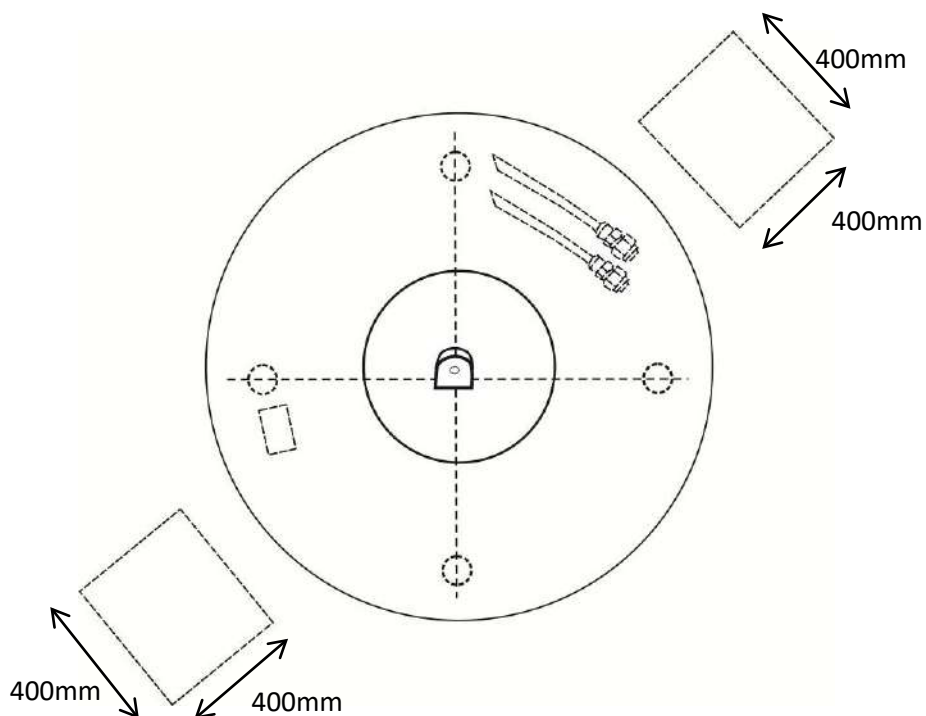

7. INSTALLATION – COMPRESSOR UNIT

Compressor unit is designed for an installation in technical room. It is a plastic box with 4 silent blocks ideally to be installed on a wall console. This part describes the fixation on a wall console.

Please refer to position of the compressor unit in terms of surrounding walls and objects.

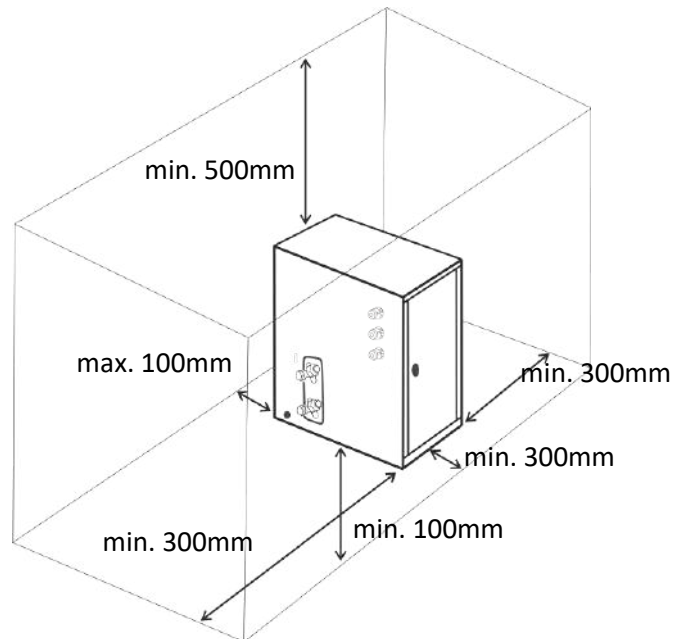

1. Locate the appropriate location for compressor unit. Drill 4 holes for fixation screws and fix the wall consoles on a wall. Make sure the wall console is leveled with spirit level with max. deviation of +/- 0.3%

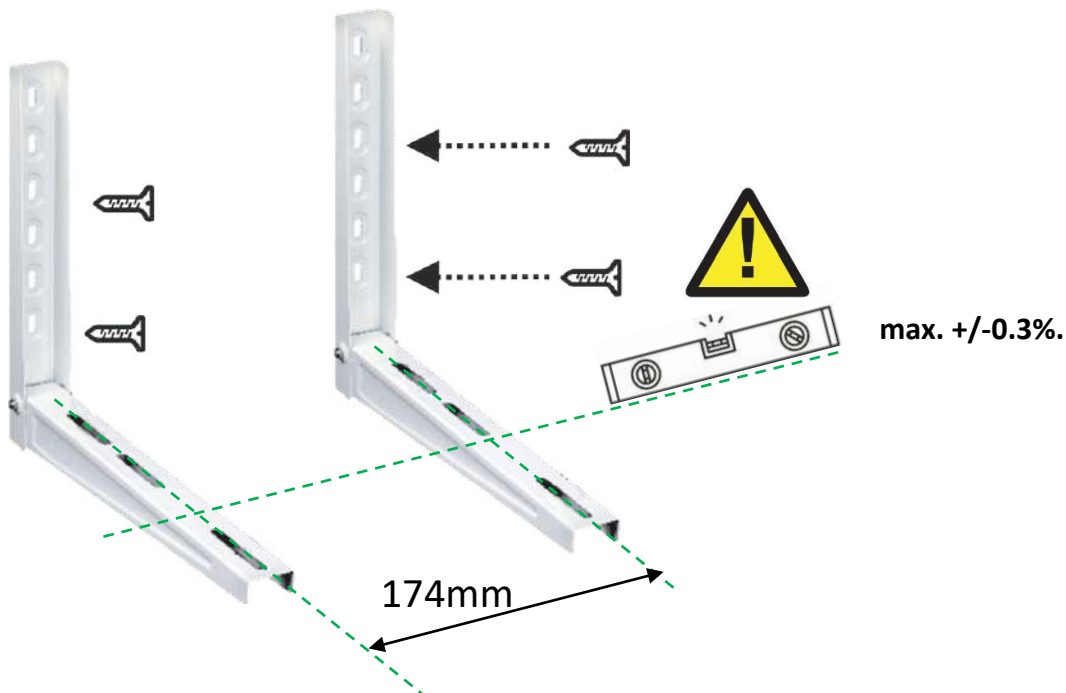

2. Mount the compressor onto the wall console. Please refer to below drawings. All nuts and screws are supplied.

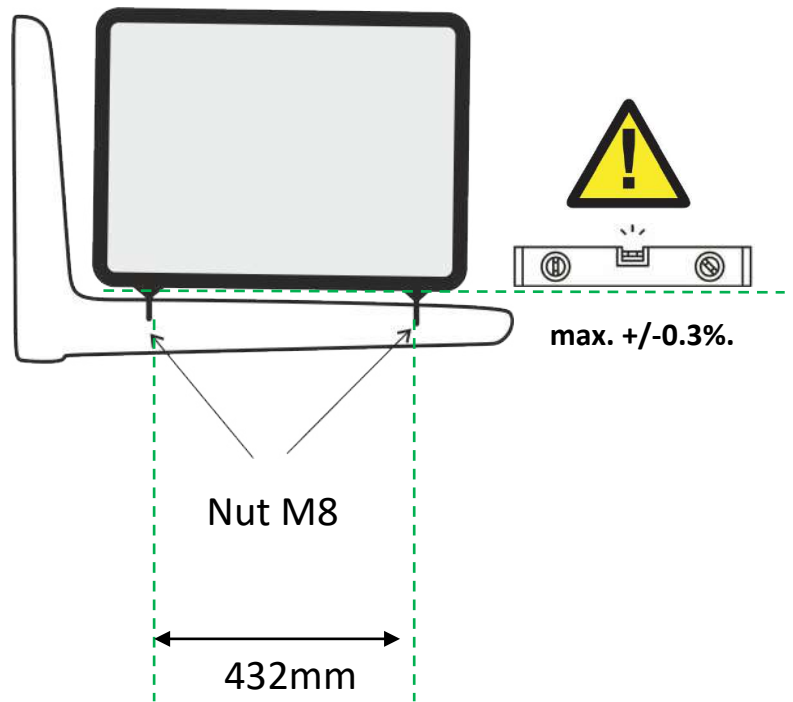

8. INSTALLATION – ELECTRICAL CONNECTION

Connection of the unit onto the mains must conform to relevant safety standards valid in your country.

Main power connection is lead to Compressor unit. Compressor unit then powers the ceiling unit.

Connection requirements: Power supply: 220-240V / 50Hz. Protection: 16A, type C, by a protective switch (RCD) with nominal differential drop-out current not exceeding 30 mA.

Main power supply cable: 2.5mm² CYSY, three cores – Live, Neutral, Earth.

The main circuit breaker switch of the compressor unit must be situated outside of the swimming pool hall. The main switch of the unit must be bipolar, with switch-out breaking of conductors L and N. An appliance for disconnecting the unit from the mains must be embedded into a firm surface. The distance of contacts, when switched off, must be at least 3 mm for all poles.

In order to protect the unit from weather anomalies it is recommended to install power surge protection class 1. B+C+D.



The connection of the appliance to the electric mains must be carried out by a certified electrician.



Please mind all electrical safety precautions from section 3.1 ELECTRICAL SAFETY

1. Please use supplied three core cable (part number 11 with markings "COMMUNICATION 1,2,3") and three core power supply cable (part number 12 with markings "CEILING UNIT L1,N1, EARTH"). Both cables are to be connected to both ceiling and compressor unit.

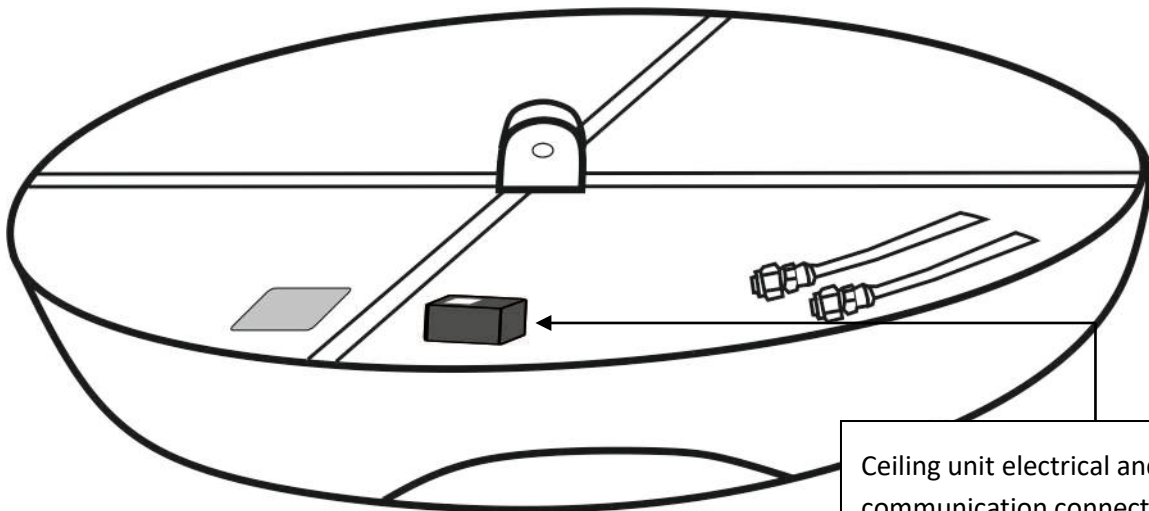

2. Please connect the connector of cable with marking "CEILING UNIT L1,N1, EARTH" to ceiling unit connector with the same marking, and connect the connector of cable with marking "COMMUNICATION 1,2,3" to ceiling unit connector with the same marking. Third connector is for speaker in case of Dry Siren Due. Connect the supplied two core cable with marking „Speaker“ (part number 14 - Bluetooth receiver speaker cable) to ceiling unit connector with the same marking.

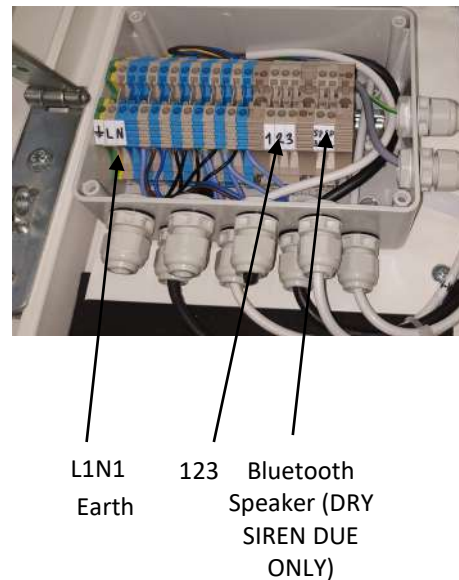
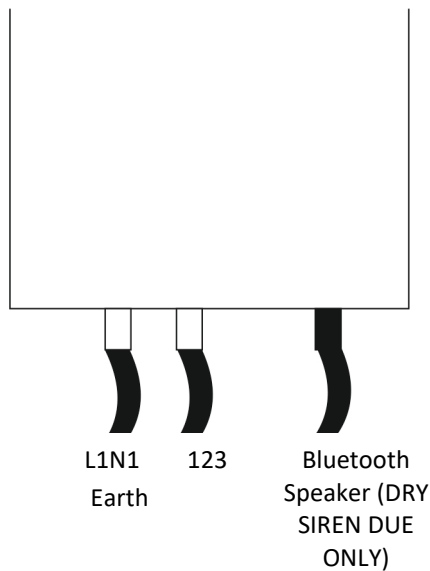

4. Take both cables and connect them onto terminals into compressor unit.

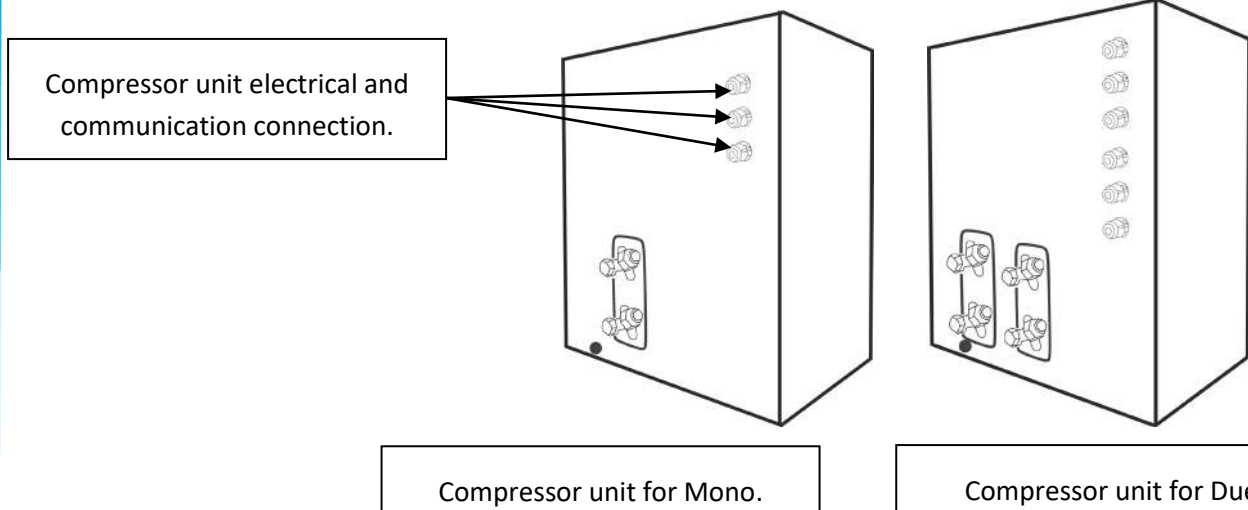

5a. Lead the cables through the cable joint connectors. Unscrew the plastic top.

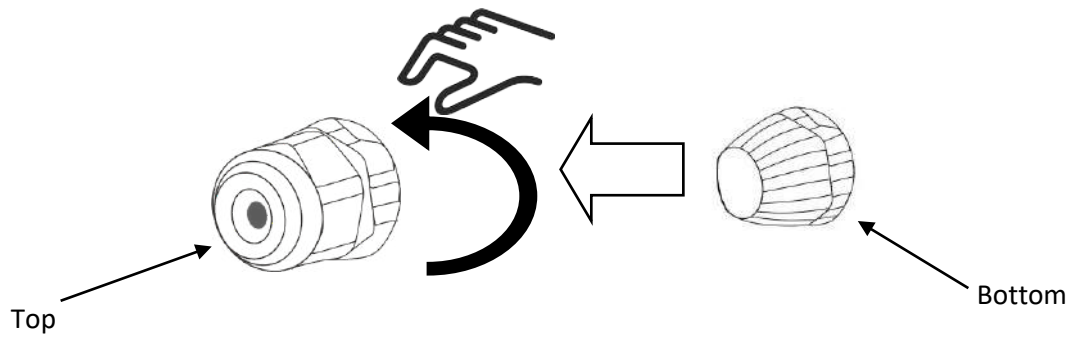

5b. Lead the cable through the top to bottom. Then tighten the top back.

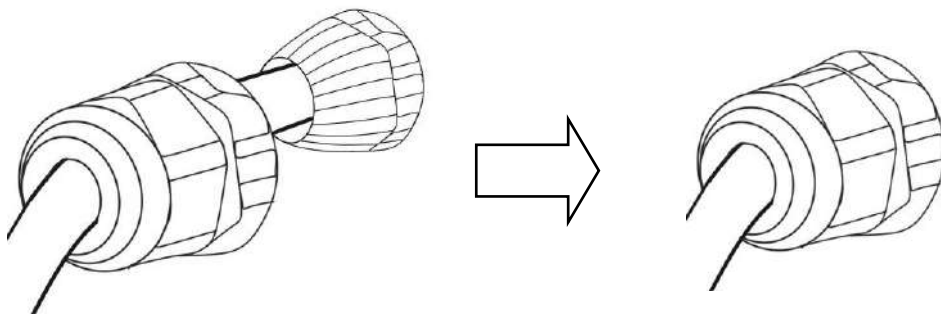

6. Please connect the ceiling unit power supply cable (L1, N1, Earth) and compressor unit main power supply cable (L, N, Earth) onto the compressor terminal connection.

7. Please connect the communication cable (1, 2, 3) for DRY SIREN mono. 1,2,3 for DRY SIREN due.

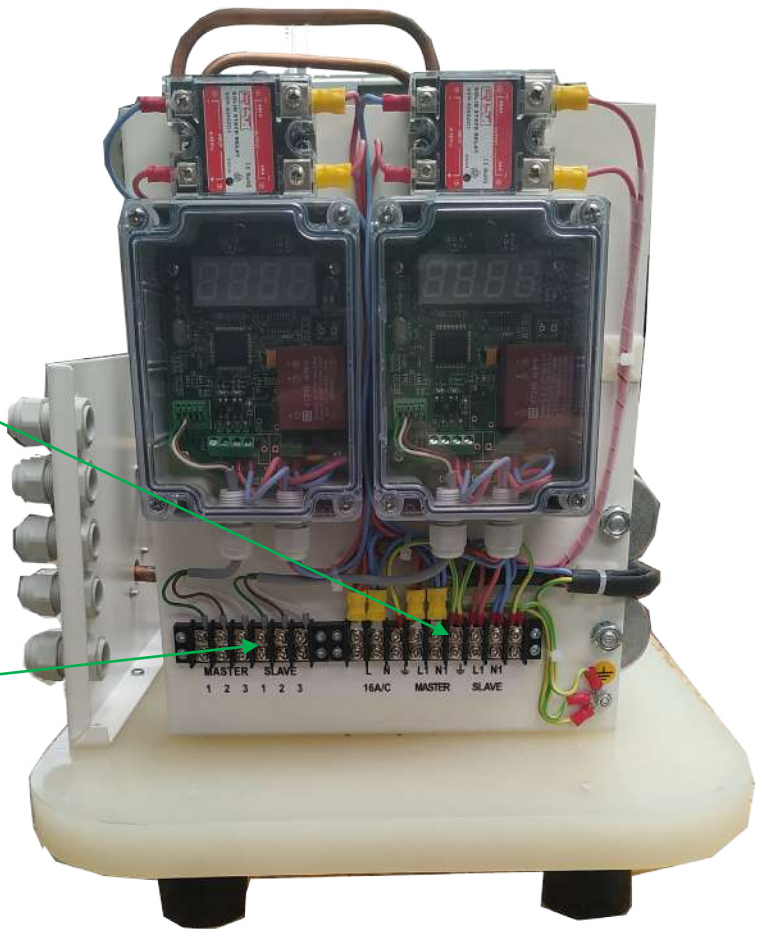

9. DRAINAGE OF CONDENSATE WATER

Condensed water is pumped from the unit upwards with total vertical discharge of 40cm (netto out of the unit 20cm) and then by the force of gravity (downwards). Unit's condensate tray is levelled to have sufficient declivity when the ceiling unit is perfectly levelled (using spirit level) with tolerance +/- 0.3%. Compressor unit uses only the force of gravity. The condensation water must be drained through a **siphon** into a municipality sewage system or into the outside environment. Please do not place the drainage hose upwards (against gravity); this will lead in unit's inability to drain the condensate water. This will subsequently cause water leakage from underneath the unit's cover and may lead to unit's malfunction, damage or failure. Also it may cause the underlying floor be wet, which creates danger of accident and harm to health resulting from unwanted slip. Manufacturer, distributor or reseller are not responsible for such damages.



Do not drink the condensate water. Do not pour or let the condensate water back to the swimming pool. It may be contained with bacteria.

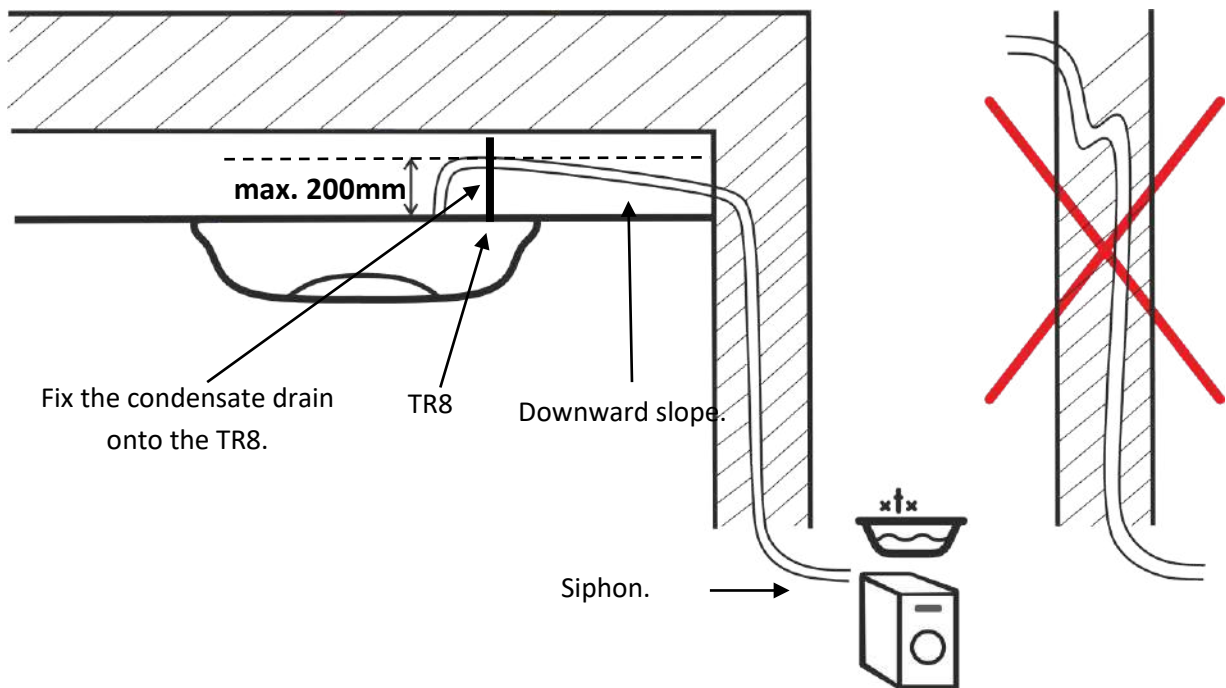

Incorrect drain installation.

Do not increase the drain after it was in downward slope.

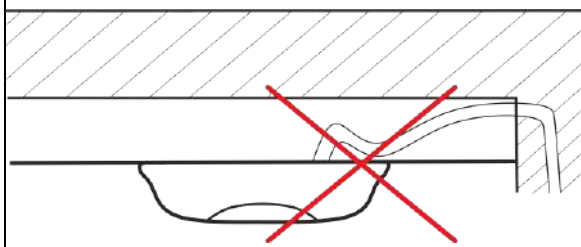

Incorrect drain installation.

Avoid 'waving'. Accumulated water in downslope 'waves' avoids normal condensate drain and will result in water leakage.



Compressor unit is supplied with a condensate drain hose. Please follow instructions below to correctly install the condensate drainage.

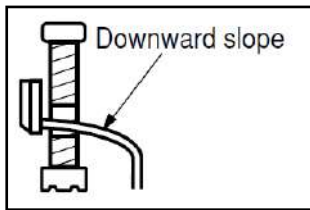

Correct drain hose

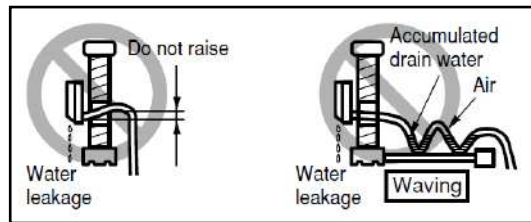

Incorrect drain hose installation.

CONDENSATE DISCHARGE

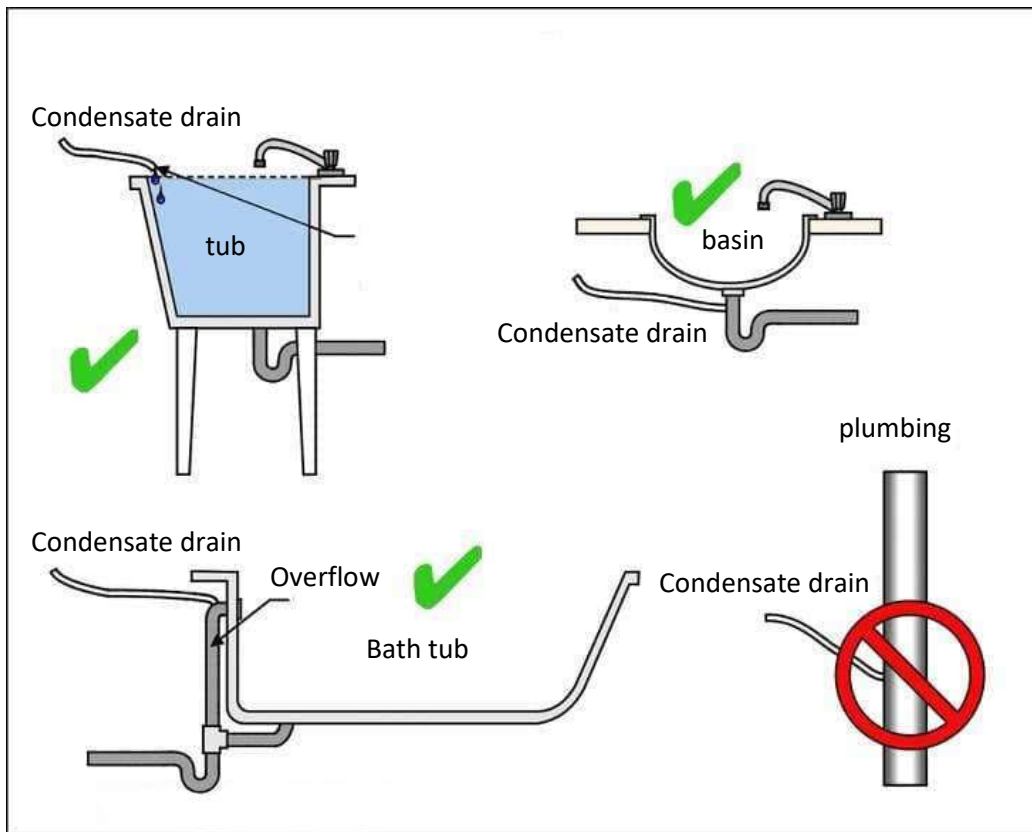

10. INSTALLATION – REFRIGERANT CONNECTION

DRY SIREN requires refrigerant circuit connection in order to operate normally. This section explains the refrigerant installation in detail. Refrigerant circuit must be sealed.



IMPORTANT: Please note that refrigerant connection can be performed by an authorized person only. The person must have a valid refrigeration license.

Compressor unit is not pre-charged with refrigerant R410A from the factory. The pre-charged amount of refrigerant is =0.00kg= R410A. The unit must be filled with 1.05kg R410A as nominal charge. This charge is enough for 8 meter long refrigerant connection. Certain amount of refrigerant must be added to the system per each meter exceeding 8m of connecting distance.



Please note that it is needed to add 30g of R410A per 1 meter for exceeding 8m connecting distances above nominal charge 1.05kg.

Piping length and elevation

Heat pump model	Pipe size				Factory pre-charged connection distance	Max. vertical distance (B)	Max. distance (A)	Additional refrigerant
	Gas (diameter)		Liquid (diameter)					
	inch	mm	inch	mm				
DRY SIREN	1/2	12.7	3/8	9.52	=0.0=	8m	20m	30g/m above 8m

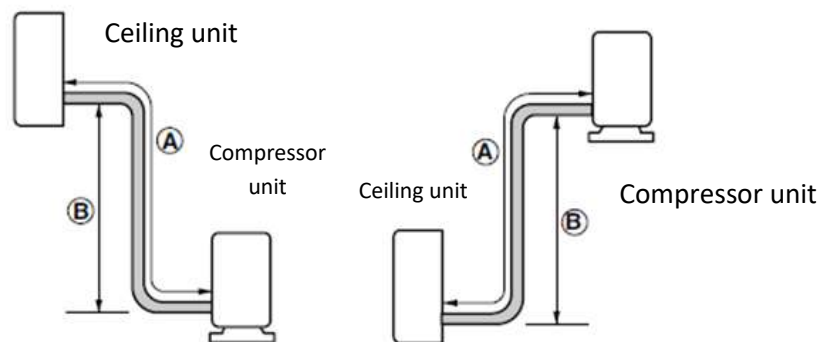

10.1 Determining the pipe length and refrigerant charge.

It is important to correctly measure the refrigerant pipe length and calculate the necessary refrigerant charge. Please refer to picture below as an example. Pipe length is 15 meters.

Factory pre-charge: 0.00kg

Nominal charge needed: 1.05kg

Additional charge: $12+3-8 = 7\text{m}$; $7 \times 0.03 = 0.21\text{kg}$

Total final charge needed: $1.05+0.21 = 1.26\text{kg R410A}$

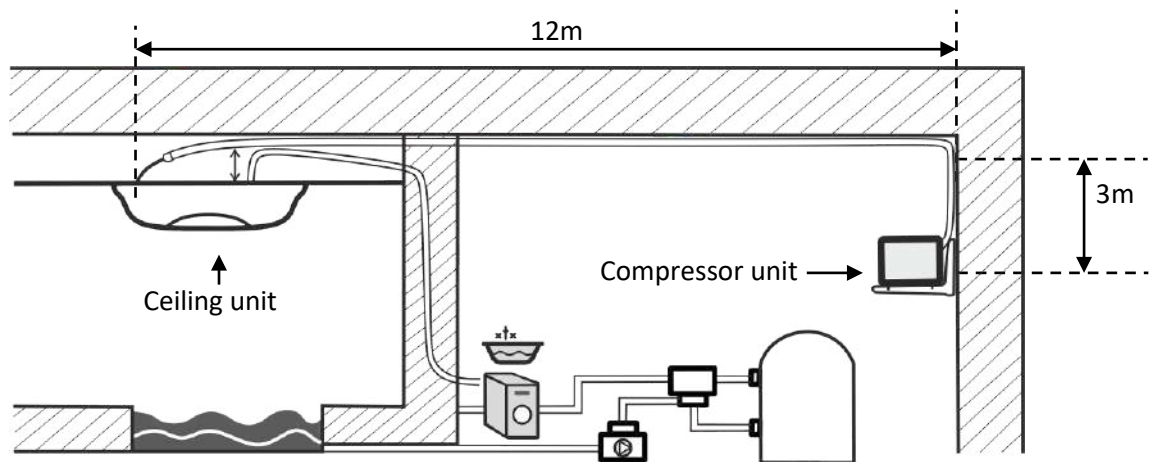

Note: The picture is illustratory and is not designed to reflect the exact measures and distances correctly.

10.2 Refrigerant piping

- I. Align the center of the pipes and sufficiently tighten the flare nut by hand. Please do so for both Suction and Discharge pipes. Suction pipe has bigger diameter. Discharge pipe has smaller diameter.
- II. Tighten the flare nuts with torque wrench until the wrench clicks. Please make sure that the direction for tightening follows the arrow on the wrench.

Pipe connection on compressor unit.

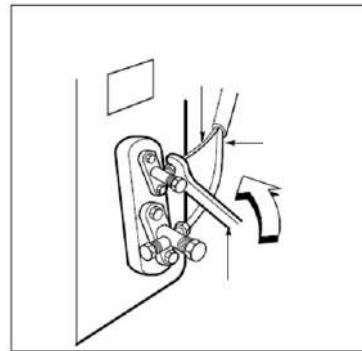
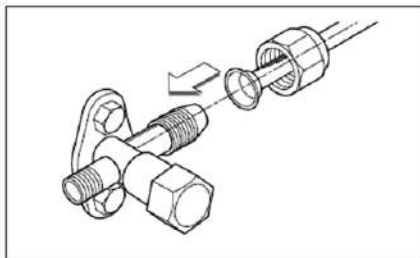

Pipe connection on ceiling unit.

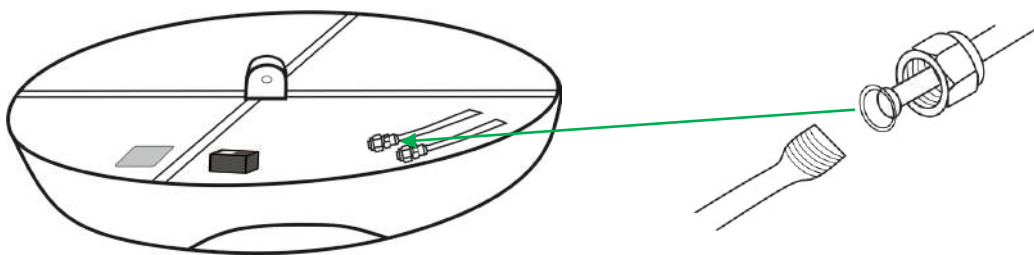

Please review below table for torque force.

Outside diameter		Torque kgf m
inch	mm	
3/8	9.52	3.4-4.2
1/2	12.7	5.5-6.6



III. Forming and insulation the piping.

The pipes must be insulated and secured with vinyl tapes. This is done in order to prevent condensation on the piping.

It is highly advised to place the piping into a plastic protector when installed in the ground (soil).

On places where piping goes through a wall or similar it is advised to use gum type sealer or construction foam to seal the openings.



Please use refrigerant copper pipes with insulation only.

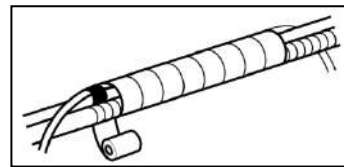

1. Compressor unit below ceiling unit

Tape the piping and interconnecting cable from down upwards. Fix the tapped piping with cable binder or equivalent onto the exterior wall. It is important to make a trap to prevent water from entering into the electro installation of the condensing unit.

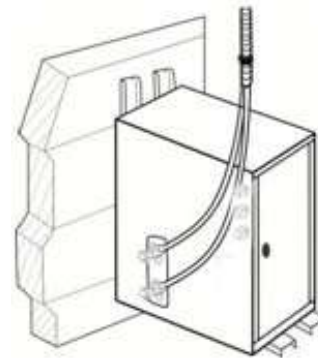

2. Compressor unit above ceiling unit

Tape the piping and interconnecting cable from down upwards. Fix the tapped piping with cable binder or equivalent onto the exterior wall. It is important to make a trap to prevent water from entering into the electro installation of the compressor unit. **On refrigerant side it is important to form a syphon to avoid compressor's oil leakage into ceiling unit coils.**

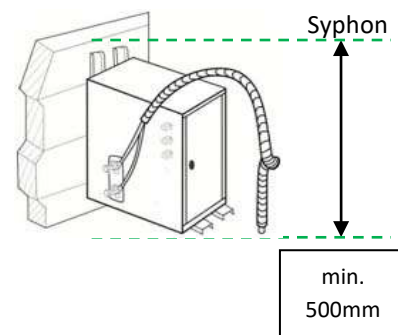

10.3 Flaring work

It is important to perform the flaring work correctly. This will have positive effect towards long-term reliability and functionality of the DRY SIREN. Defective or incorrect flaring work is the most common cause for gas leakage or other refrigerant circuit defect. Both then result in continuous decrease of DRY SIREN efficiency and eventually lead into security turning off, malfunction, failure or damage.



Warranty does not cover any product, property or personal damages or losses that are a result of incorrect flaring work, gas leakage, incorrect welding work or improper material used.

When cutting the pipes and cables, please mind the following:

1. Measure the distance between the water and the condensing unit.
2. Cut the pipes a little longer than measured distance.
3. Cut the cable 1.5m longer than the pipe length.

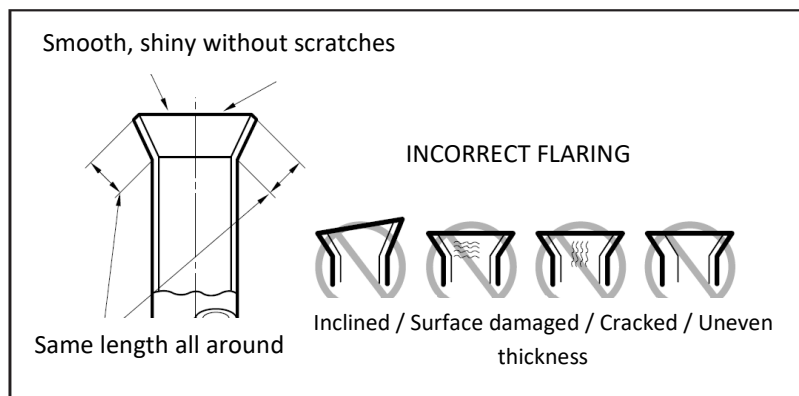
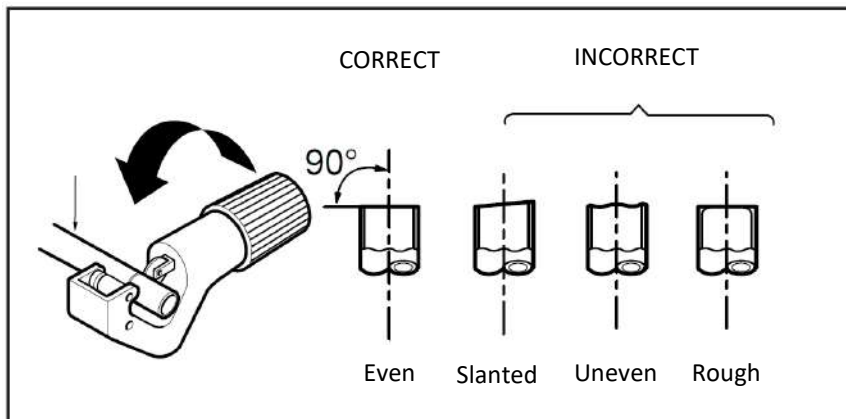

Pressure test / Air purging / Filling the refrigerant

Sometimes bits of air and moisture remains in the refrigerant circuit. If this is not treated, following symptoms may appear on DRY SIREN:

1. Pressure in the system rises.
2. Operating current rises.
3. Dehumidification efficiency drops.
4. Blockage of Electronic expansion valve due to frozen moisture resulting in complete failure of the unit.
5. Corrosion of refrigerant circuit.

It is thus highly advised to take a leak test after evacuating the complete system. Leak test can be performed with usual methods using manifold valve and/or soap water. Air purging can be performed by most commonly applied methods with vacuum pump. This Installation and user manual elaborates vacuum pump method.

Air purging with vacuum pump / Filling the refrigerant

1. Preparation

- a. Check that each tube (both suction and discharge) between the ceiling and compressor units have been properly connected and all wiring for the test run has been completed.
- b. Remove the service valve caps from the suction side on the compressor unit. Please note that both the suction and the discharge side service valves on the compressor unit are kept closed at this stage.

2. Vacuum test

- a. With a service valve wrench (imbus wrench), turn the suction and discharge valve counter-clockwise to fully open both valves.
- b. Connect the charge hose end described in the preceding steps to the vacuum pump to evacuate the piping. Confirm the "Lo" knob of the manifold valve is open. Then, run the vacuum pump. The operation time for evacuation varies with tubing length and capacity of the pump. The following table shows the time required for evacuation when using a vacuum pump of 30 gal/h power.

Required time for evacuation when 30 gal/h vacuum pump model is used	
Tube length less than 10m	Tube length more than 10m
Minimum 20 minutes	Minimum 30 minutes

- c. When the desired vacuum is reached, close the "Lo" knob of the manifold valve and stop the vacuum pump.
- d. Close the valve on charging hose at vacuum pump.

3. Refrigerant filling

- a. Now remove the vacuum pump and bring the refrigerant bottle and charging scales. Connect the disconnected hose (point d above) to refrigerant bottle (liquid side). Place the bottle on charging scales and turn the scales on. Please make sure no object, pipe, cable or other touches the bottle or charging scales. Otherwise weight misreading may occur.
- b. Please close the valve at hose at suction side of compressor unit.
- c. Open the manifold 'Lo'.
- d. Open the valve at hose at refrigerant bottle.
- e. Open the bottle's valve.
- f. Zero the charging scales out.
- g. Open the valve at hose at suction side of compressor unit. Please mind that the compressor unit is still off.
- h. Wait until the unit sucks necessary amount of refrigerant. Charging scales typically shows the weight as negative number (how much was taken out from the bottle).

- i. Sometimes the necessary amount of refrigerant is not sucked into the system by itself. The reason can be:
- room air temperature / bottle temperature too low
 - Low bottle pressure (low amount of gas in bottle)
 - Restriction in copper pipes
 - Incorrect copper pipe installation
 - Malfunctioning / defective valve, hose or manifold valve

To resolve, please proceed step-by-step:

- Ensure stable room and bottle temperature of +20°C to + 30°C, ideal is when bottle temperature is higher than air temperature
- Make sure that bottle contains at least a double amount of required amount of refrigerant
- Check the entire copper pipe installation and make sure it all complies this User's manual
- Check the functionality of valves, hoses and manifold valve
- If all OK, you need to help the filling with a compressor ON. This is done by turning the power supply to the unit on and actually turning the unit on into a dehumidification mode (i.e. compressor on). This can be done only by an Android application. Please see section 11 UNIT TEST – PAIRING for more details. Please **DO NOT RUN THE UNIT WITHOUT REQUIRED AMOUNT OF REFRIGERANT.**

- j. When the required amount of refrigerant has been filled into the system, first close the valve at suction at compressor unit and remove the valve from compressor unit. Please make sure you close the valve on bottle and 'Lo' knob on manifold valve.
- k. Put service valve caps back at both suction and discharge side service valves and fasten them tight. Please note those suction and discharge valves are to be kept open for the unit's operation. Make sure all copper pipes are properly insulation against external conditions to prevent condensation and water leakage and also burnt.
- l. This completes the refrigerant work.



Always use charging scales for refrigerant filling. Do not use pressure as indicator of the correct refrigerant amount.



Please note that above flaring and refrigerant work must be performed correctly with utmost care. Any non-compliance with above may and will likely lead into unit's malfunction, failure or damage. Such state means complete warranty void and manufacturer, distributor or reseller cannot be taken responsible in such case for any property or personal damage or loss.

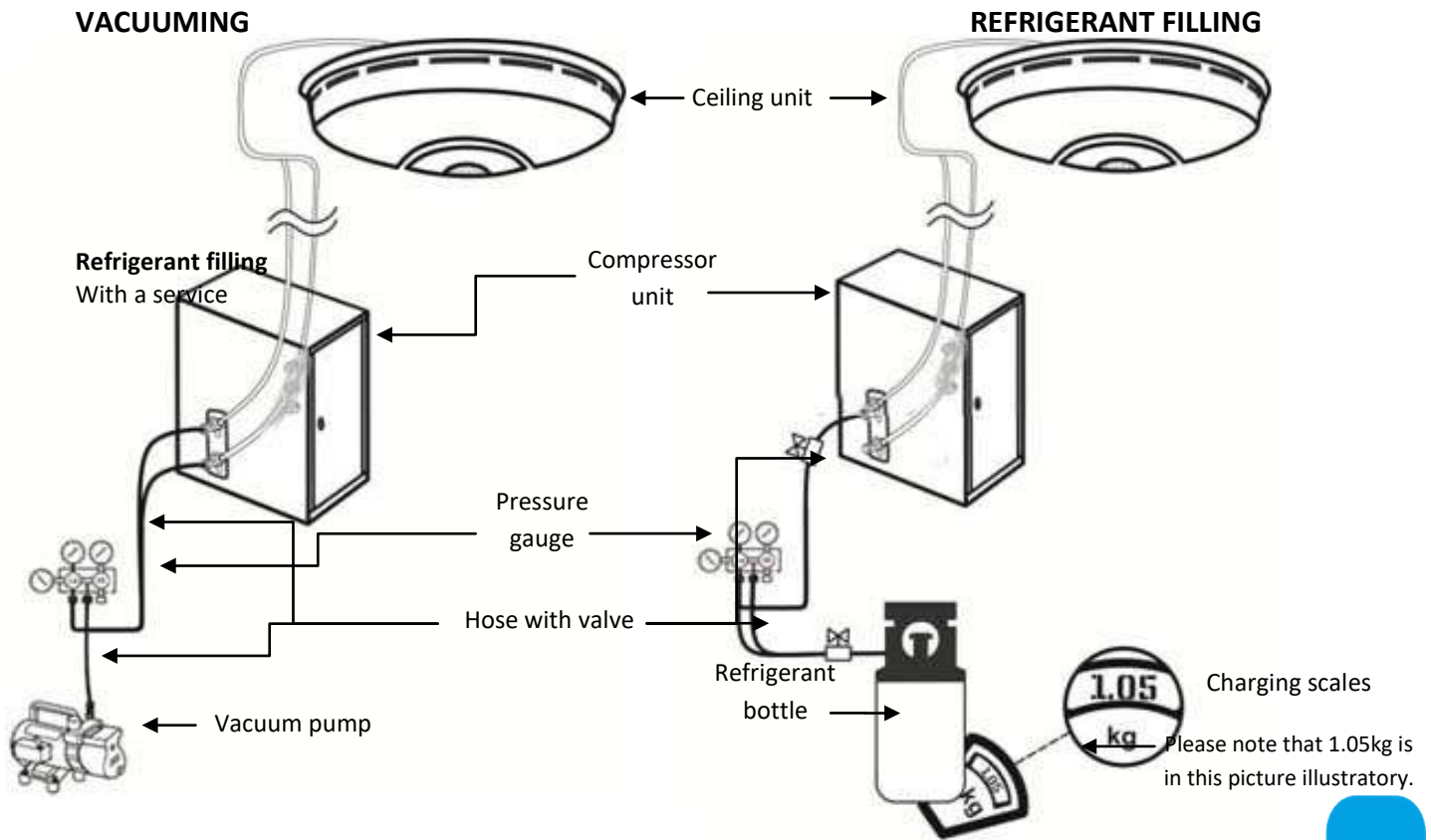

11. UNIT TEST - PAIRING

DRY SIREN is designed to be controlled exclusively via a mobile device application. In order to control the unit you need pair it with your mobile device. You will need mobile device, WIFI connection and DRY SIREN LICENCE information. DRY SIREN's pairing is protected by double password entry. This is to avoid third parties logging into your DRY SIREN device. DRY SIREN license plate is located on the inside of the compressor unit's cover. The plate looks like following:

 **MICROWELL**

DRY SIREN LICENCE

SN Master: XXXXXXXXXXXX

SN Slave: XXXXXXXXXXXX

APP LOGIN: XXXXXXXXXXXX

APP PASSWORD: *****

BLUETOOTH SPEAKER ID: JPM2021

DATE: XX.XX.XXXX

 **MICROWELL**

EXAMPLE

SN Master: 502df413acbb

SN Slave: 502df410d30d

APP LOGIN: 502df413acbb

APP PASSWORD: 123456

BLUETOOTH SPEAKER ID: JPM2021

DATE: 01.01.2020

Android version:

1. Turn your Android device on. Please wait until the device starts and goes to home screen.

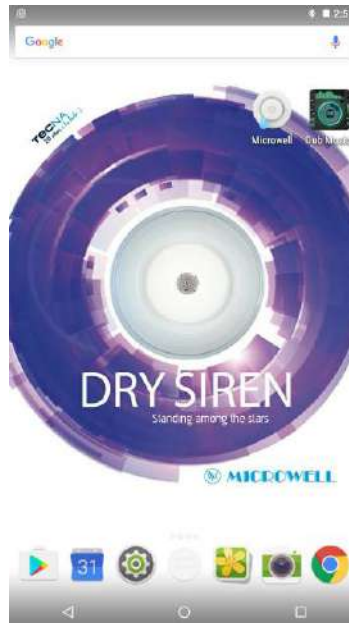

2. Connect the device to your WIFI network (your device's user interface may differ from the illustrations below).

Go to settings



Go to Wi-Fi

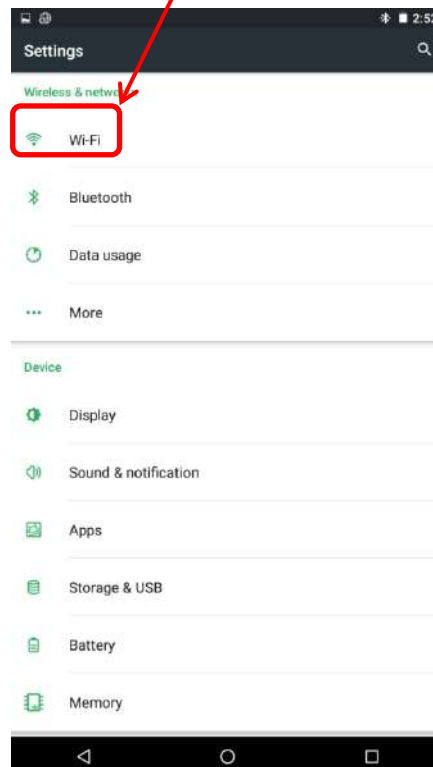

Select your home WIFI network
(in our case 'MicrowellAP')

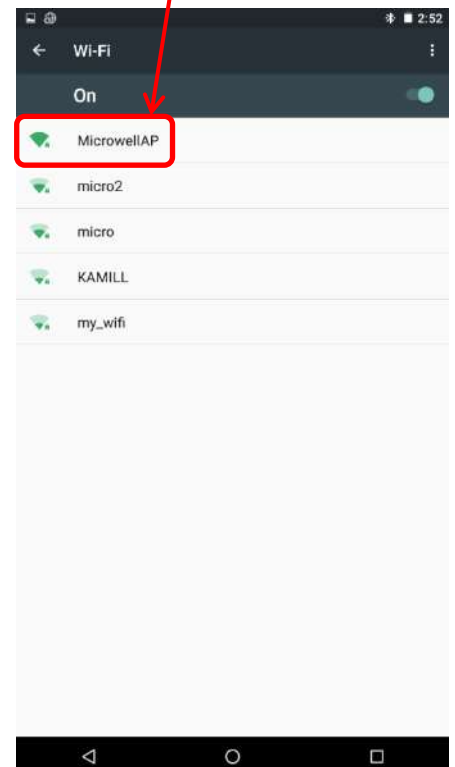

If necessary insert network password and press "CONNECT"

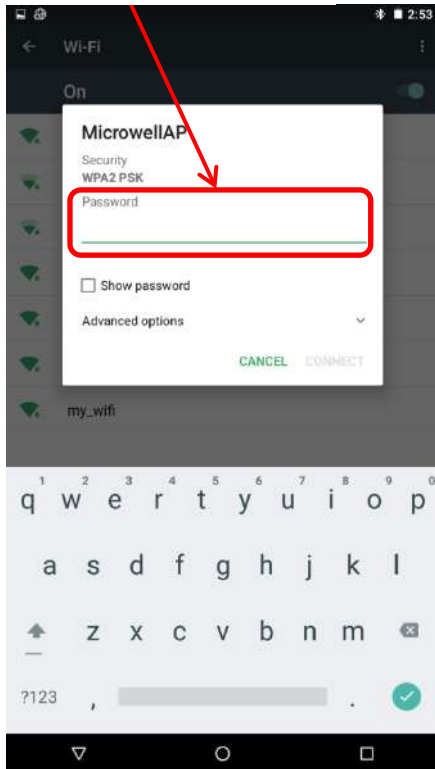

After you are successfully connected proceed to next step

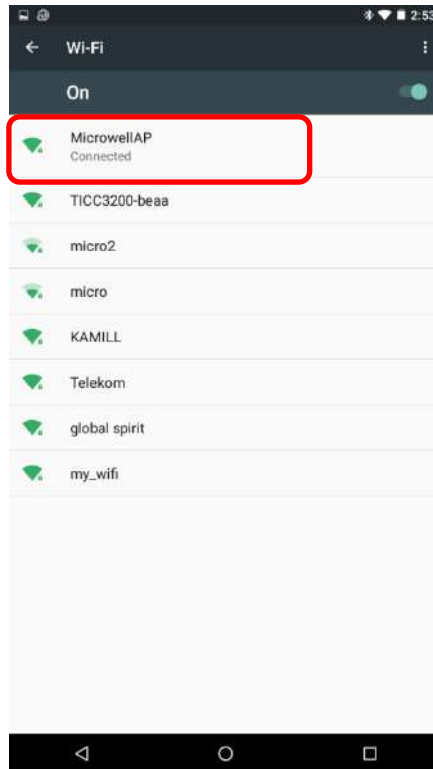

3. Open "Play store" and download the application. You may use keyword "MICROWELL" to find the application named "MICROWELL DRY SIREN", or use direct link: <https://play.google.com/store/apps/details?id=com.triosoft.microwell>

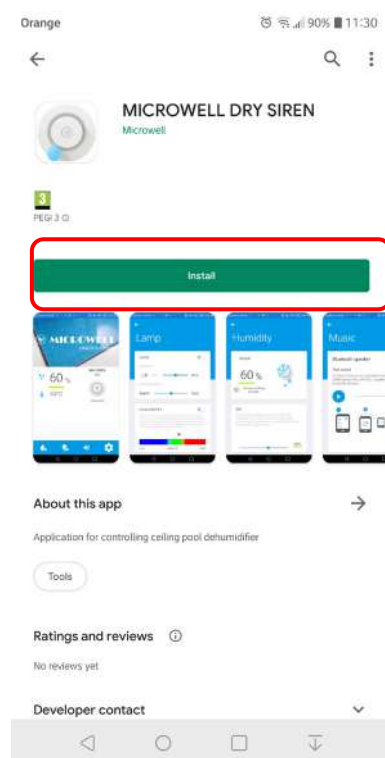
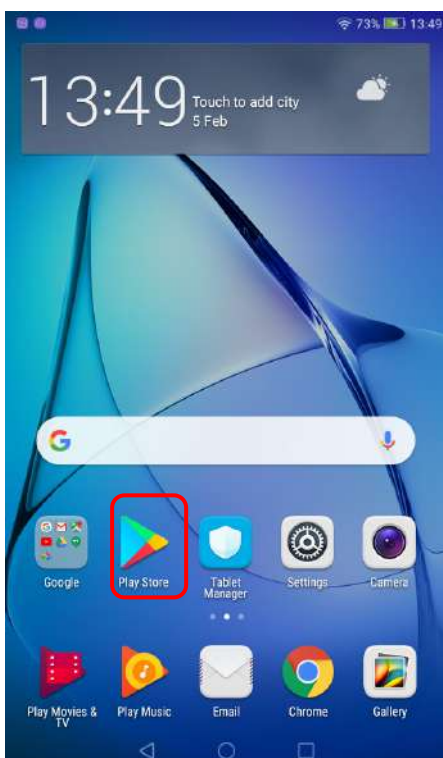

4. After successful installation open the 'Microwell' application on home screen. Use the information from the licence plate (on the side of compressor unit) to log into application (APP LOGIN and APP PASSWORD):

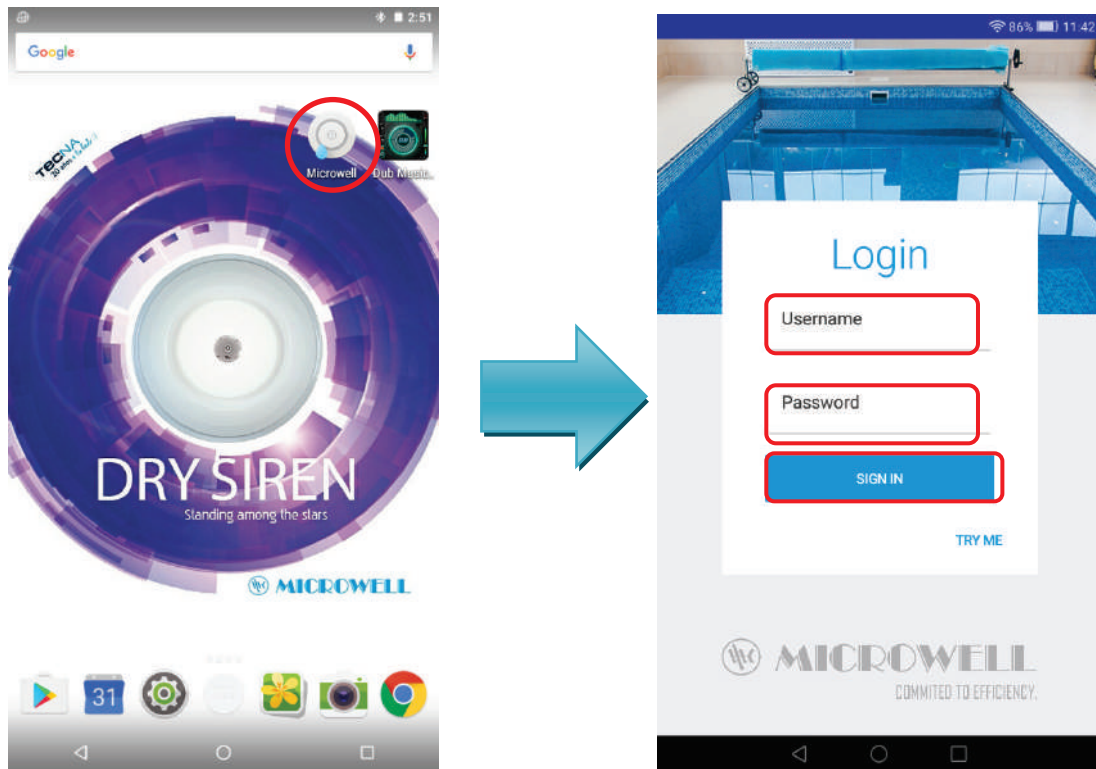

5. On first startup you need to pair DRY SIREN so the pairing process starts immediately. Press "ENTER SERIAL NUMBER" and enter serial number of Dry Siren (located on the licence plate) then press "CONFIGURE" to proceed.

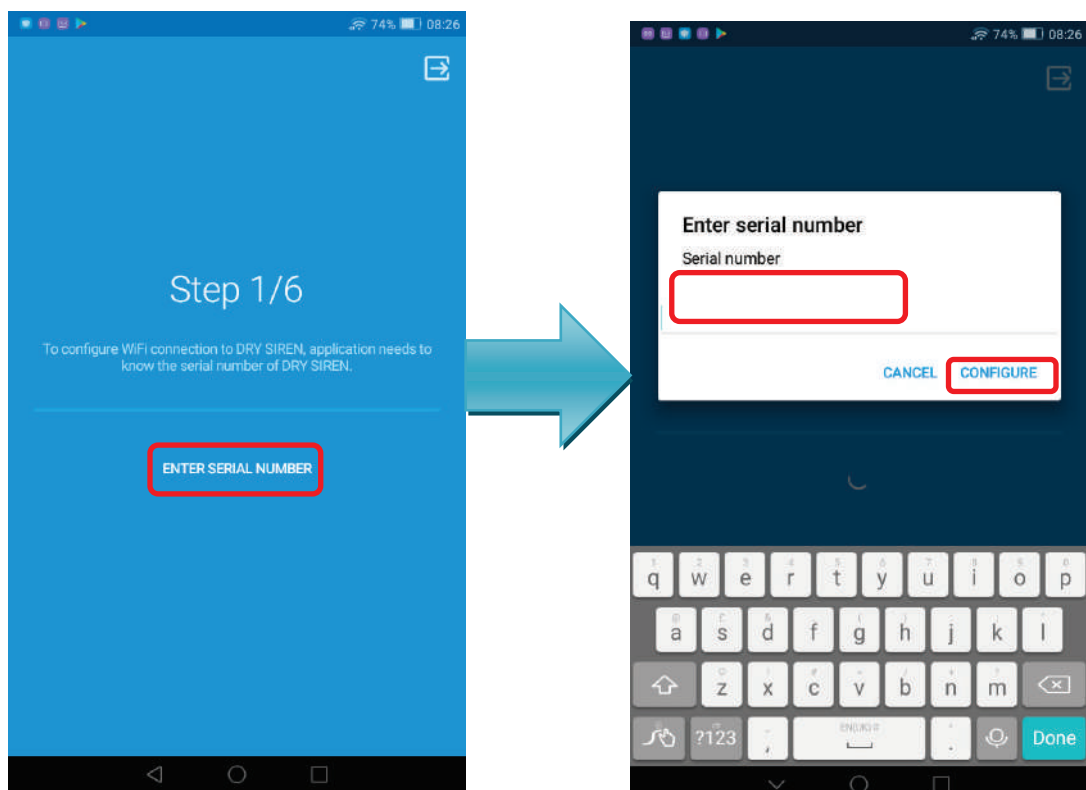

6. On the next screen press "FIND DRY SIREN" then choose Dry Siren wifi connection.

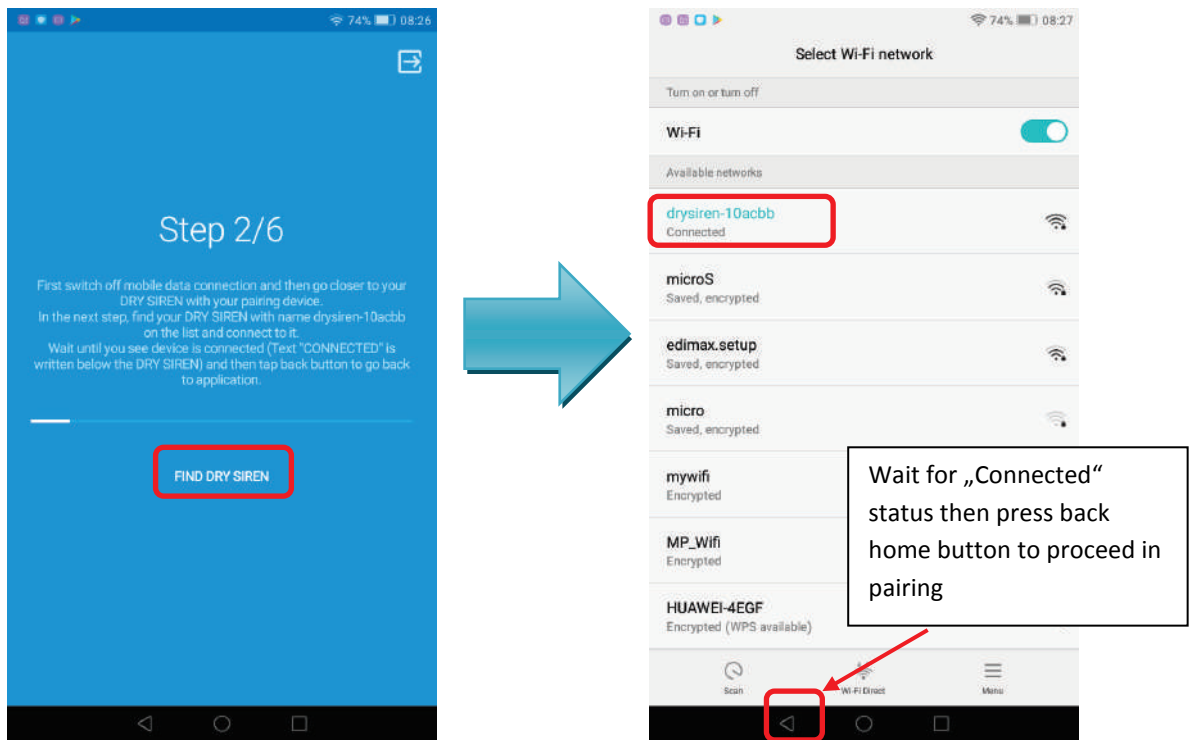

7. Select home WIFI network you want the Dry Siren to be paired to. You will have to input password of WIFI network then press „CONNECT“.

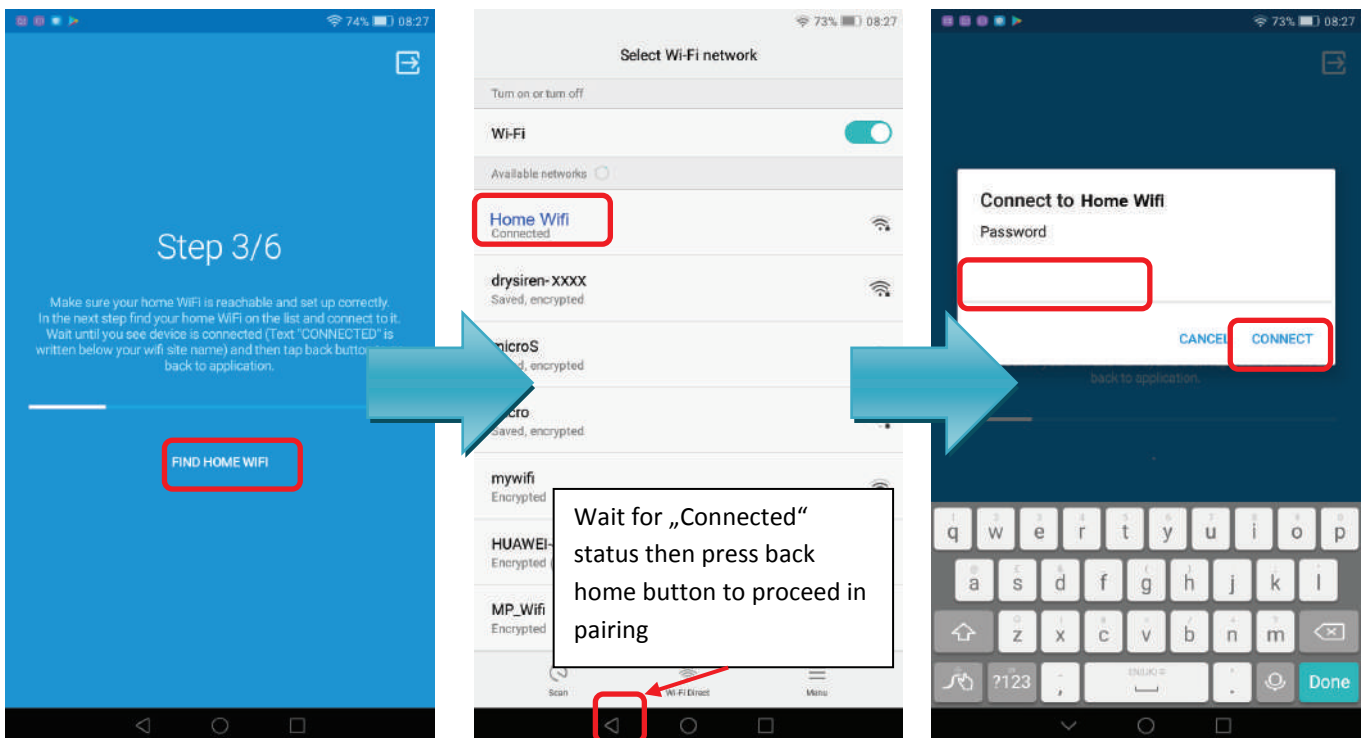

8. On the next screen press "SELECT DRY SIREN" then choose Dry Siren wifi connection again.

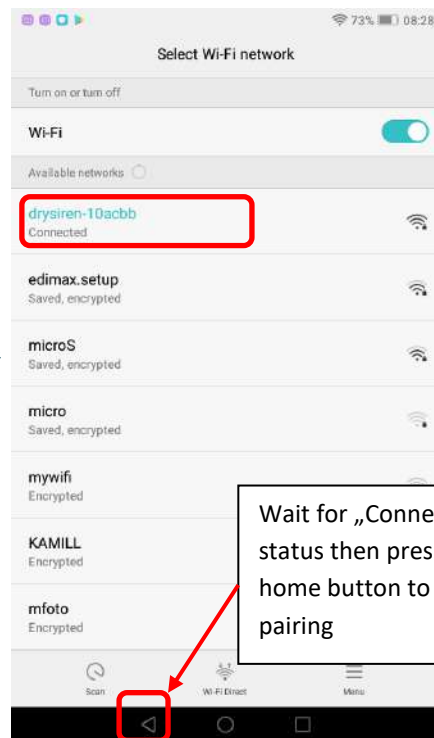
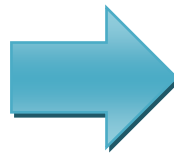
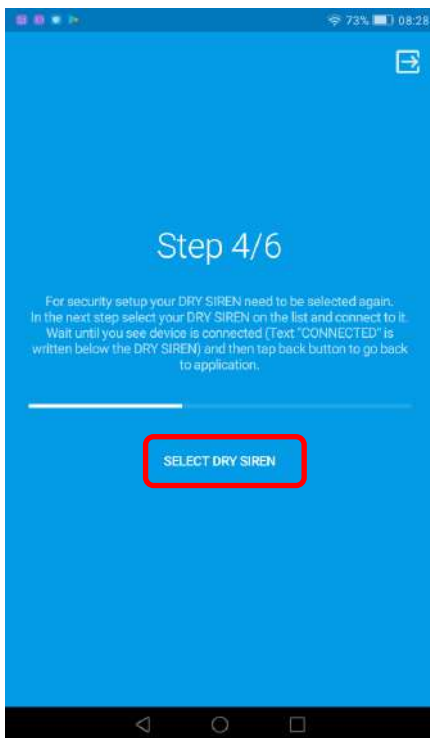

9. In the final step select home WIFI again

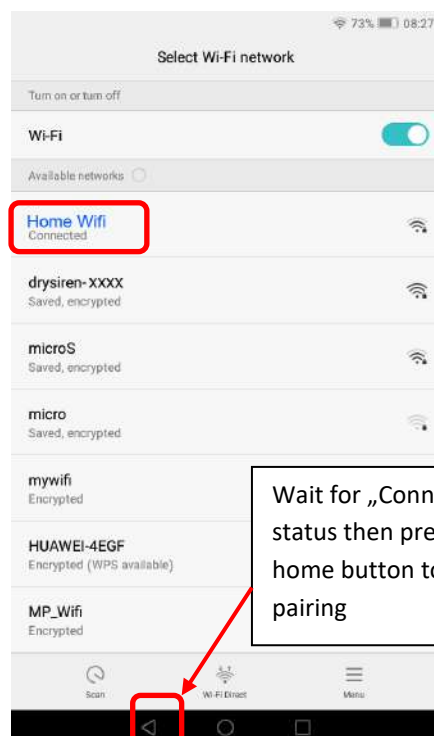
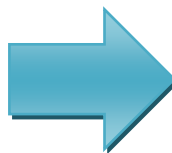
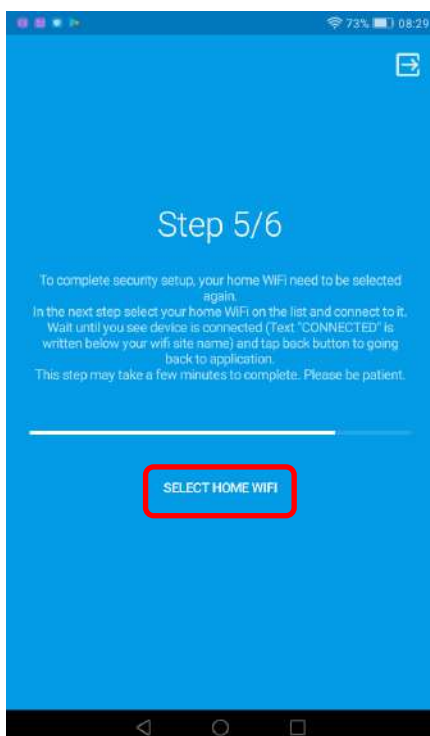

10. Please note that step 6/6 may take up to 5 minutes to complete. There is nothing wrong if it takes a bit longer than previous steps so be patient. If there is working internet connection, correct password and all working properly, your setup is complete after step 6/6 is finished. Press "START USING DRY SIREN" to start using your pool dehumidifier.

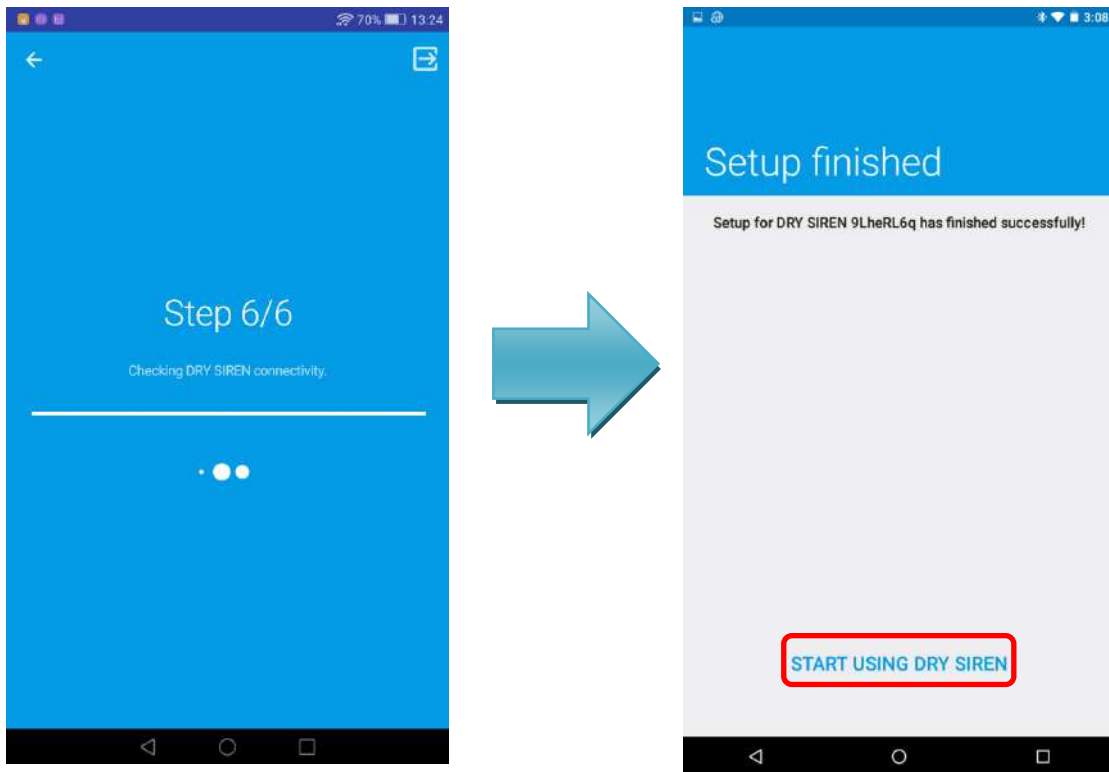

11. Now you are in Microwell application home screen and ready to use it.

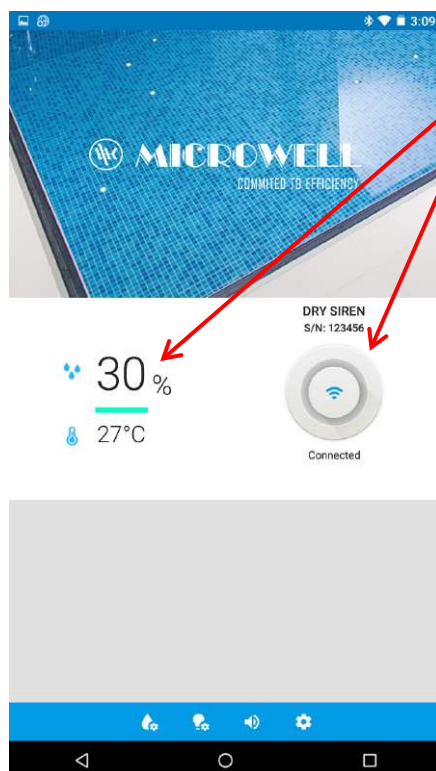

DRY SIREN is paired and working properly.

iOS version:

1. Turn your iOS device on. Please wait until the device starts and goes to home screen.
Connect the device to your WIFI network (your device's user interface may differ from the illustrations below).

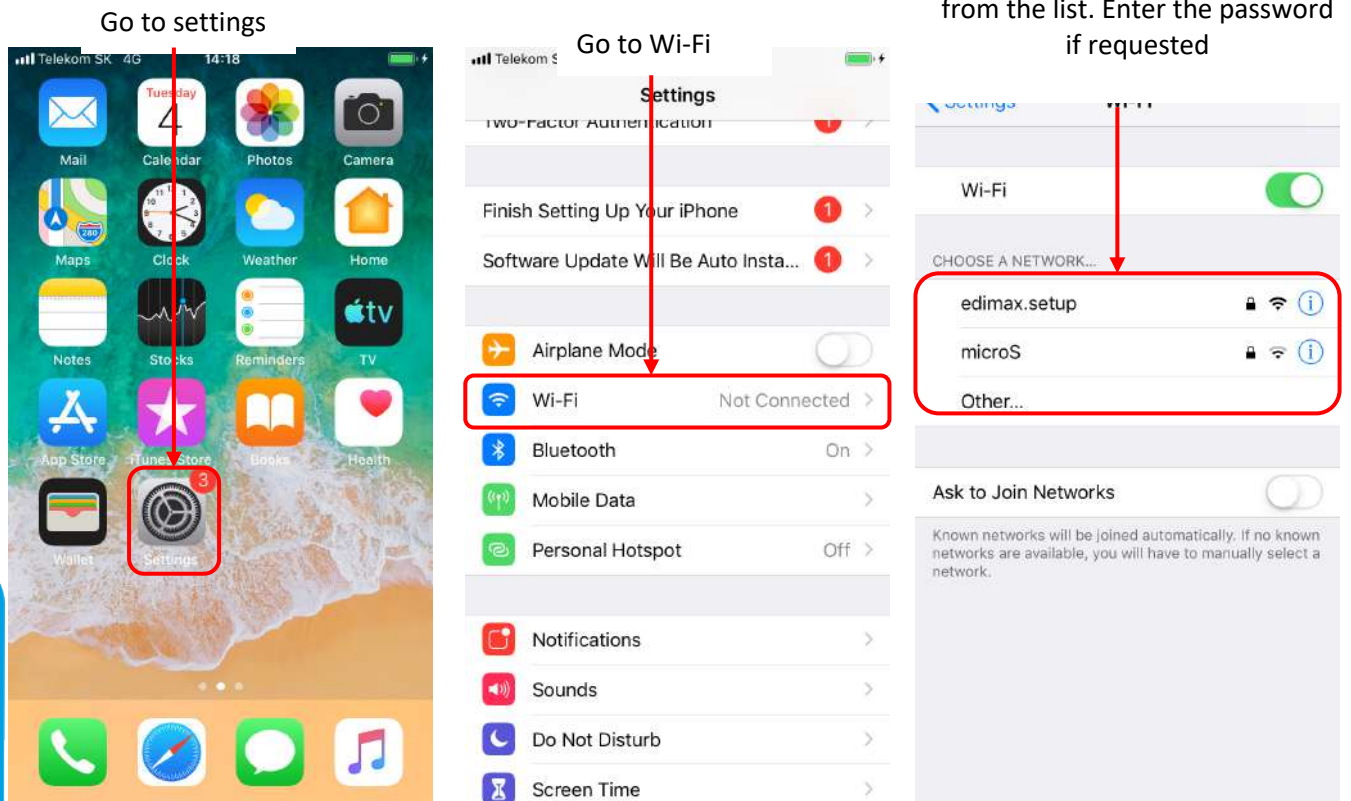

2. Open "App store" and download the application. You may use keyword "MICROWELL" to find the application named "MICROWELL DRY SIREN", or use direct link:
<https://apps.apple.com/sk/app/microwell-dry-siren/id1490579798>

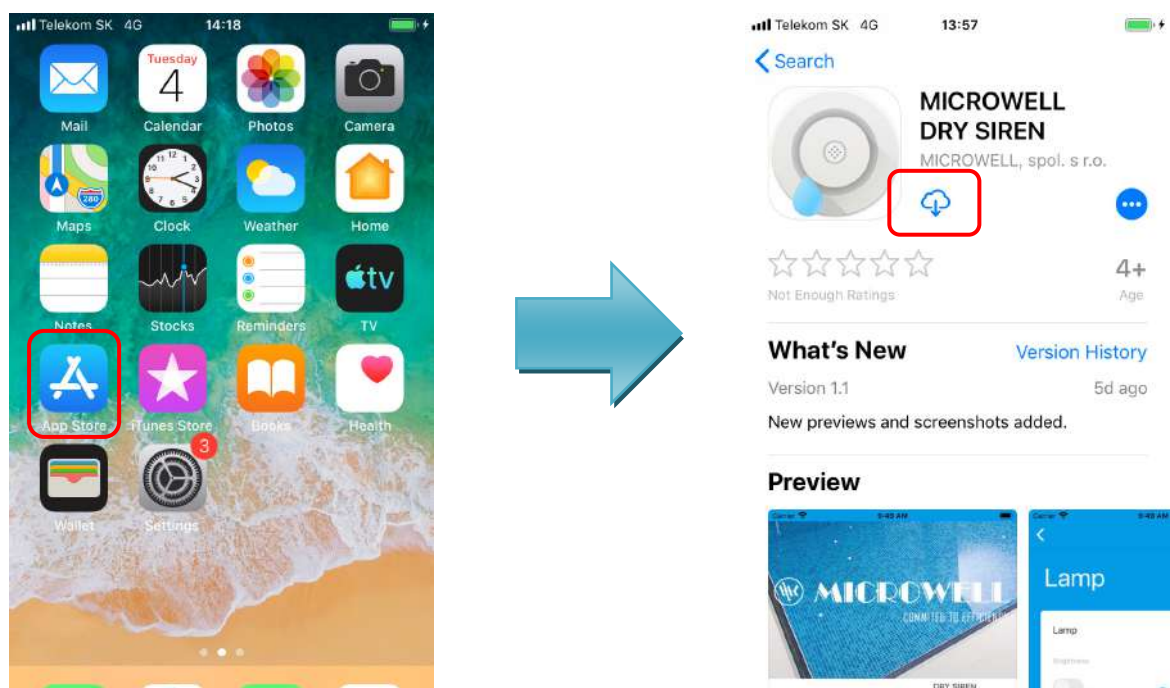

3. After successful installation open the 'Microwell' application on home screen. Use the information from the licence plate (on the side of compressor unit) to log into application (APP LOGIN and APP PASSWORD):

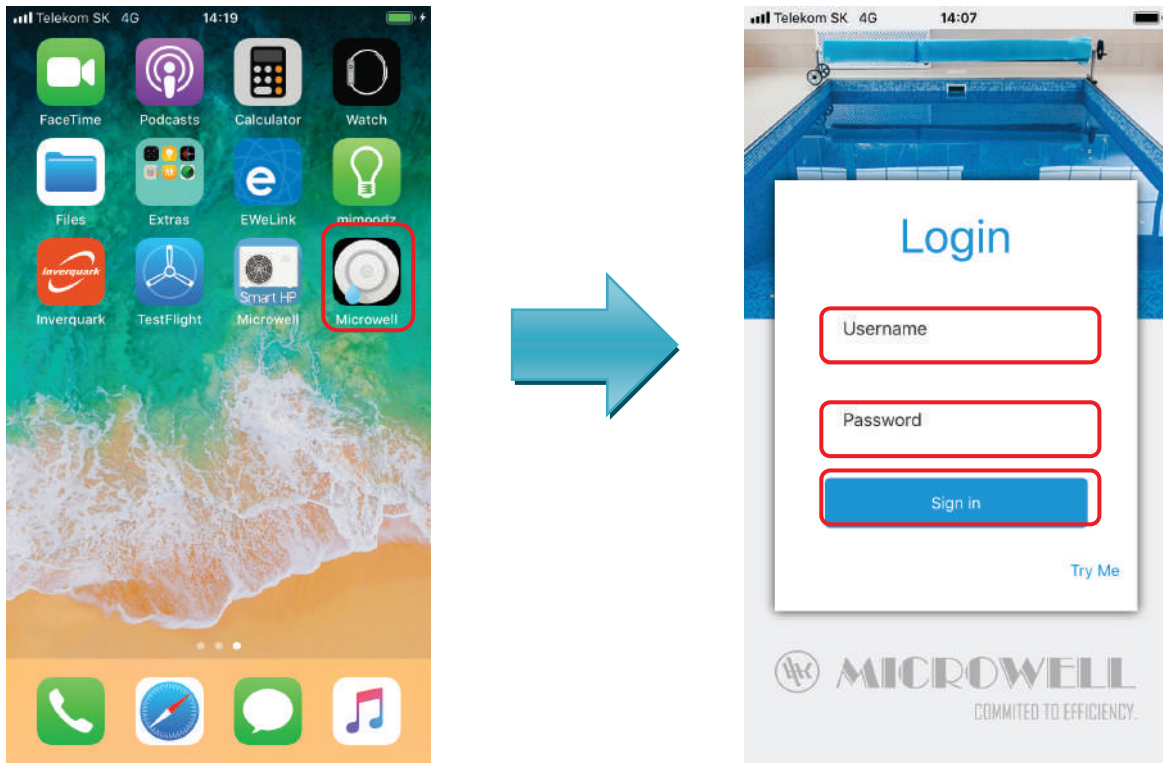

4. On first startup you need to pair DRY SIREN so the pairing process starts immediately. Press "ENTER SERIAL NUMBER" and enter serial number (located on the licence plate) of Dry Siren then press "CONFIGURE" to proceed.

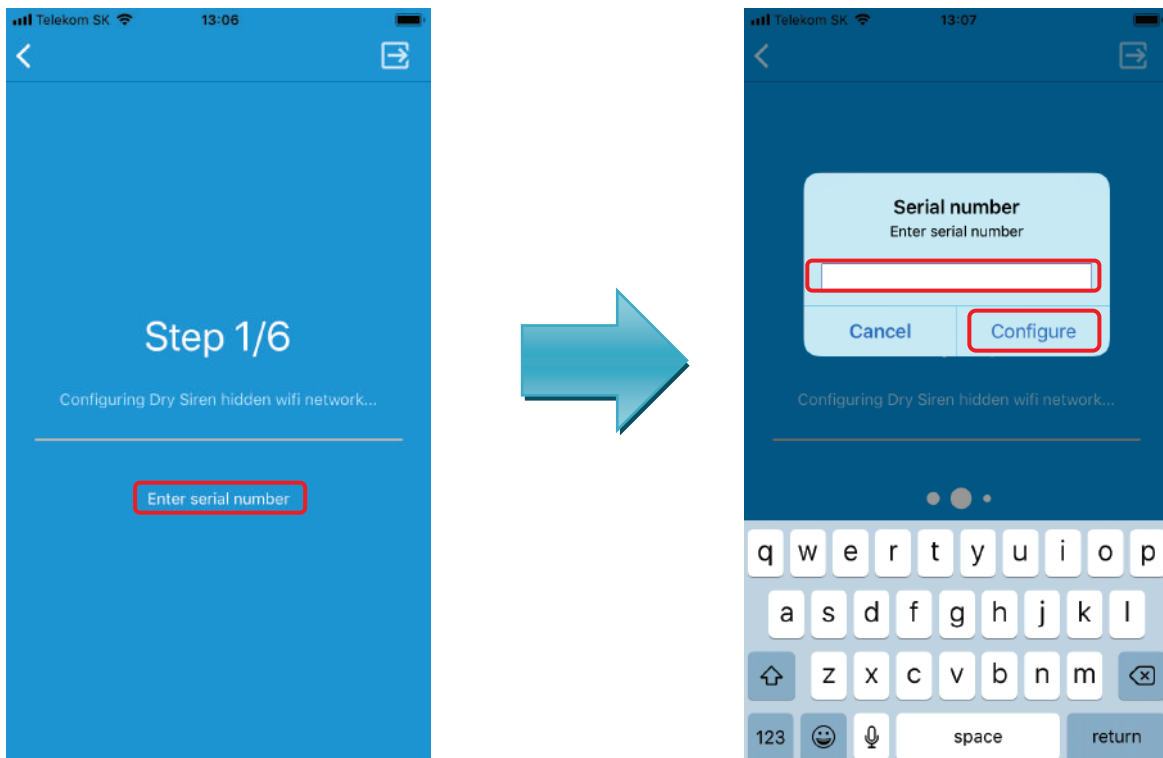

5. On the next screen the application automatically recognizes the Dry Siren. Press "Join" to proceed.

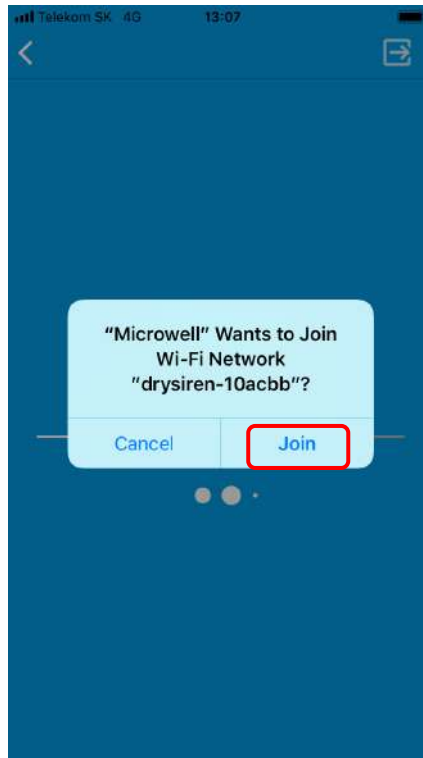

6. Input home WIFI network name (SSID) you want the Dry Siren to be paired to. You will have to input password of WIFI network then press „CONNECT“.

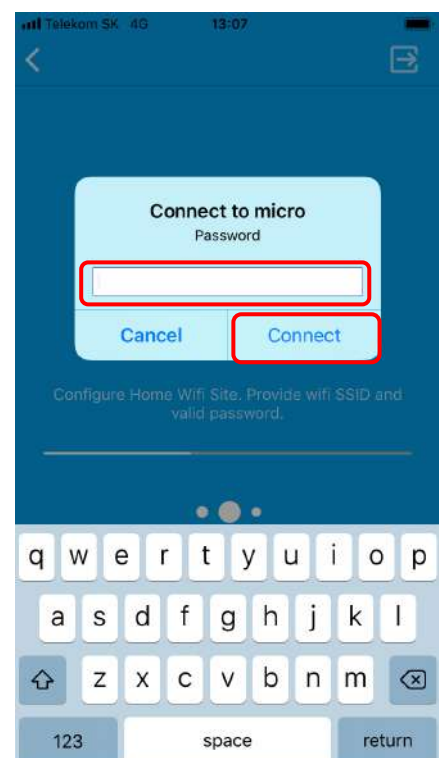
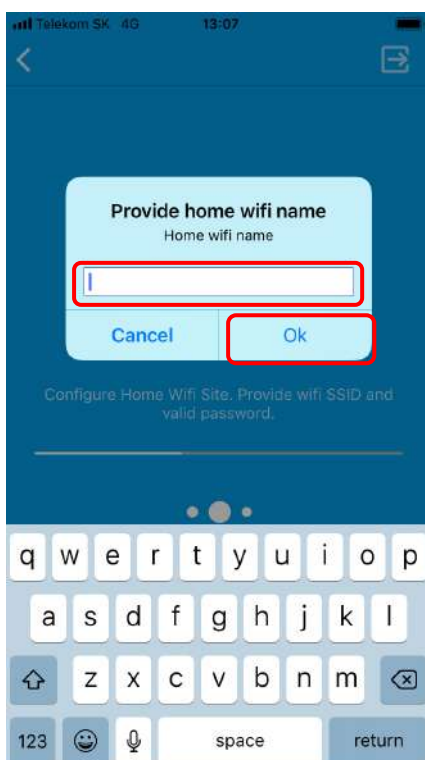

7. On the next screens you will have to press "Join" to connect to corresponding WIFI networks (home WIFI -> Dry Siren WIFI -> home WIFI again). Just press "Join" on every screen until finished.

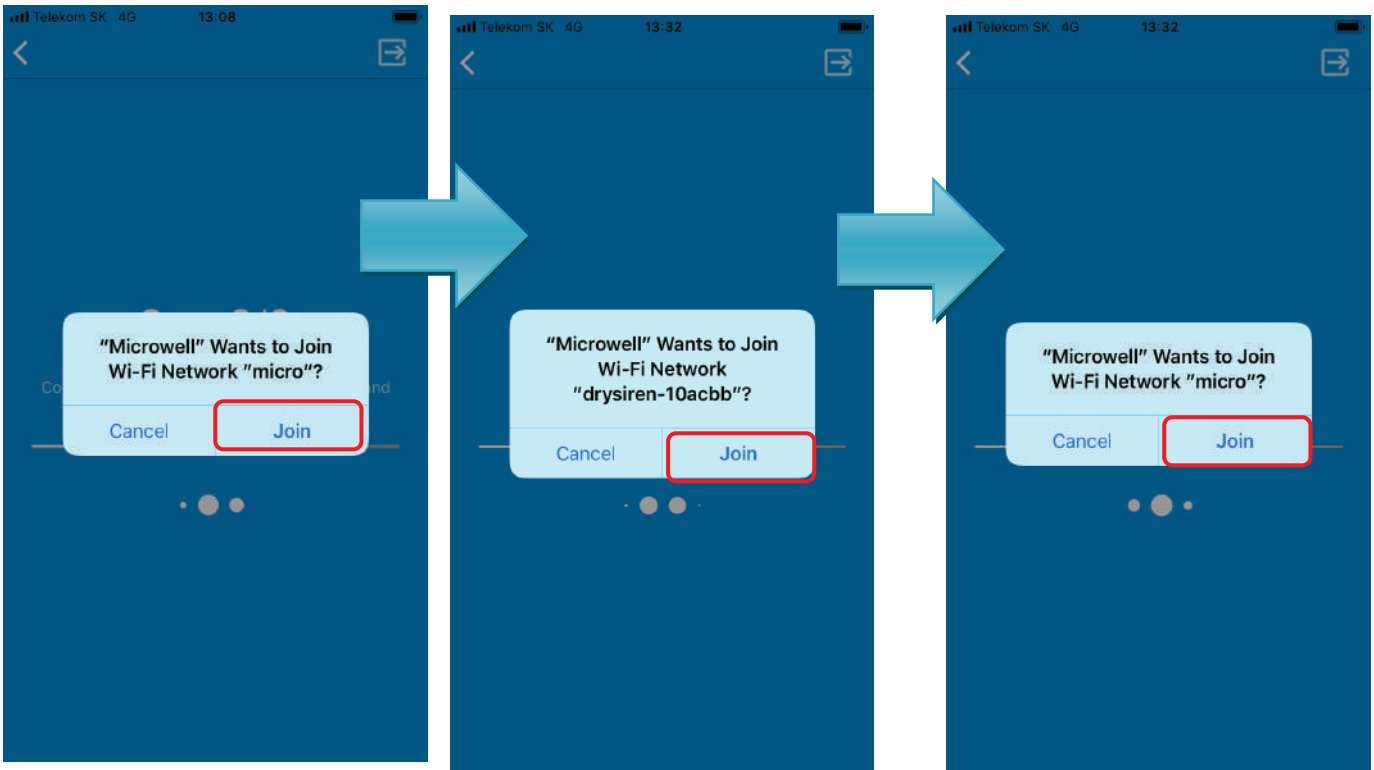

8. Please note that step 6/6 may take up to 5 minutes to complete. There is nothing wrong if it takes a bit longer than previous steps so be patient. If there is working internet connection, correct password and all working properly, your setup is complete after step 6/6 is finished. Press "START USING DRY SIREN" to start using your pool dehumidifier.

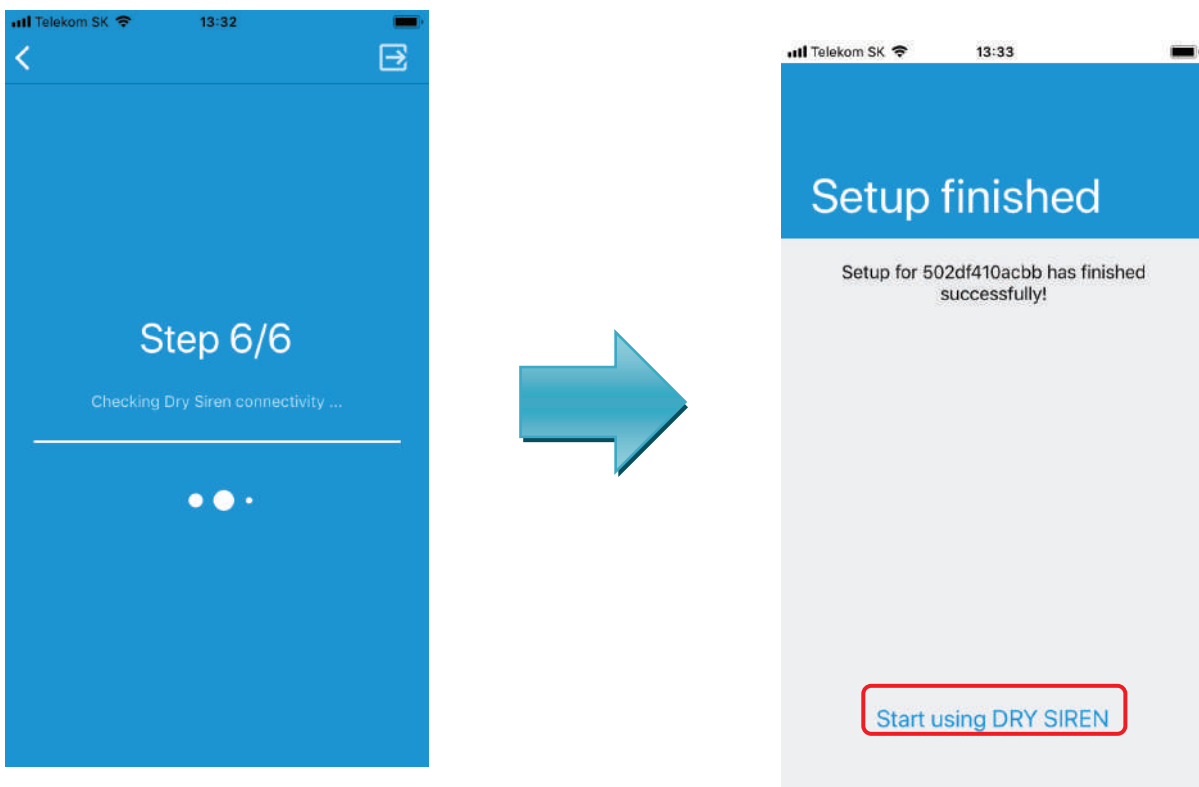

9. Now you are in Microwell application home screen and ready to use it.



DRY SIREN is paired and working properly.

To exit the application, simply close it on your device. Do not use Sign out for this purpose. Sign out will sign you out of the application. You will need the application Login ID and Password to sign in again. Please note that if you are signed out of the application you cannot control the DRY SIREN.

Note: The control is not restricted to 1 device. You can install the application on as many devices as you wish and log in from different devices to control your Dry Siren. You will need the log in data from the licence plate.

11.1 AFTER PAIRING, TEST RUN

After you have successfully paired the device you can run it for testing. When the unit is given command to dehumidify (required humidity below actual) in order to protect the compressor, the units starts to collect water after 3minutes. Minimum water collection time (compressor on) is 5 minutes.

Please turn to next section for more information about application description and control.



RECOMMENDATION: *Cover your pool when not used. It will reduce the amount of vapor in the air and energy costs needed to operate your dehumidifier.*

DRY SIREN remembers the pairing. If there is a power supply cut or you turn the unit off. After the unit is turned back on it will be connected automatically to the server. This does not apply if your WIFI NETWORK ID has changed, or your WIFI NETWORK PASSWORD has changed.

12. MOBILE APPLICATION - INSTRUCTIONS FOR USE

12.1 Control

DRY SIREN is controlled by an Android DRY SIREN application over WIFI. When DRY SIREN is plugged into the mains and is correctly installed, it will turn on and work on factory preset settings. The unit will operate to achieve 60% relative humidity with auto light and microLIGHT+. Bluetooth speaker will be also activated. Control over WIFI and mobile application allows the user to take over full control of the unit, dehumidification process, LED lamp, microLIGHT+ and Bluetooth speaker.



Do not run the unit without required amount of refrigerant. Before you proceed make sure that all installation (electrical, refrigerant, etc.) According to this user's manual had been done correctly and in full compliance to this user's manual.

Description of the home screen

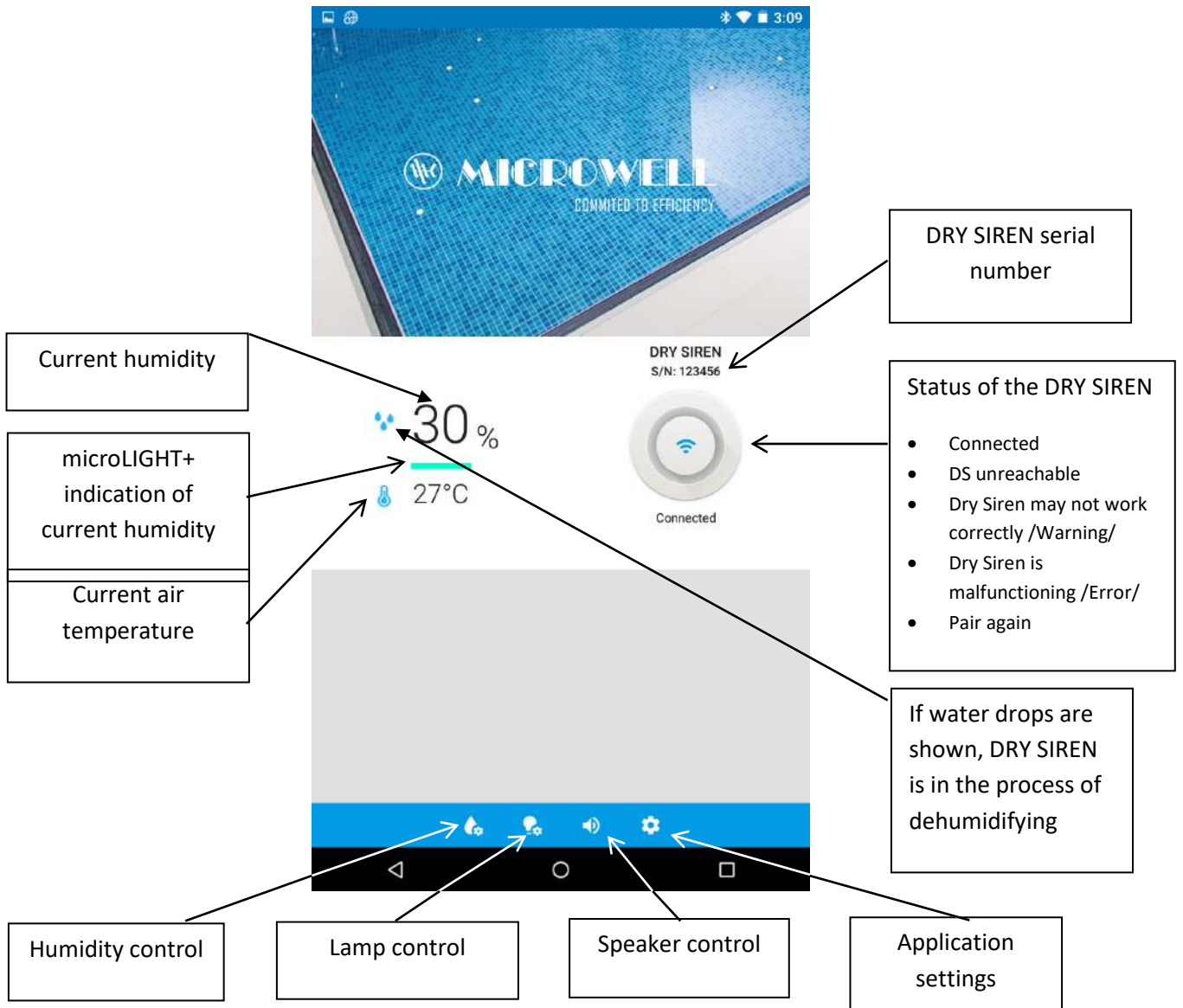

Humidity control

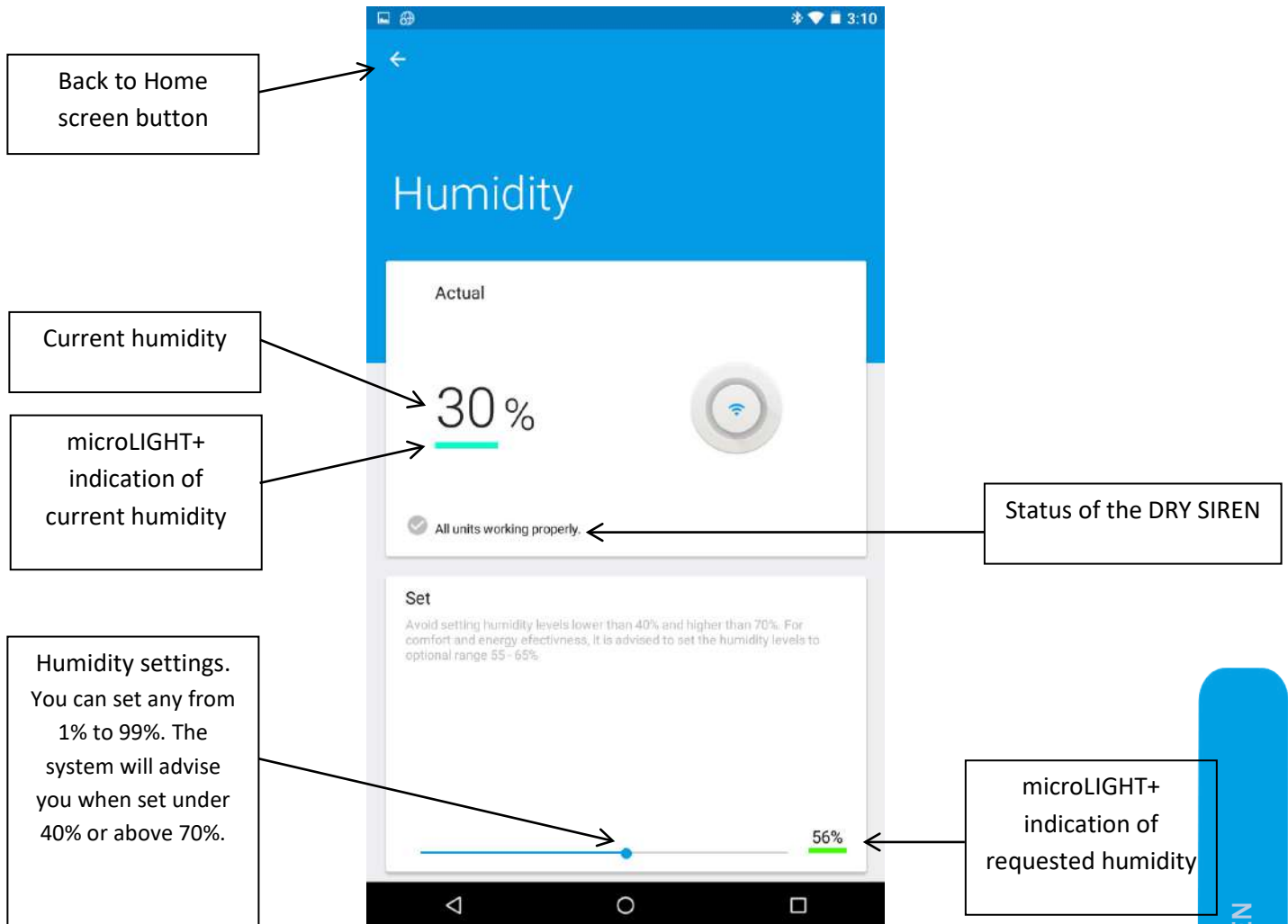

Lamp control

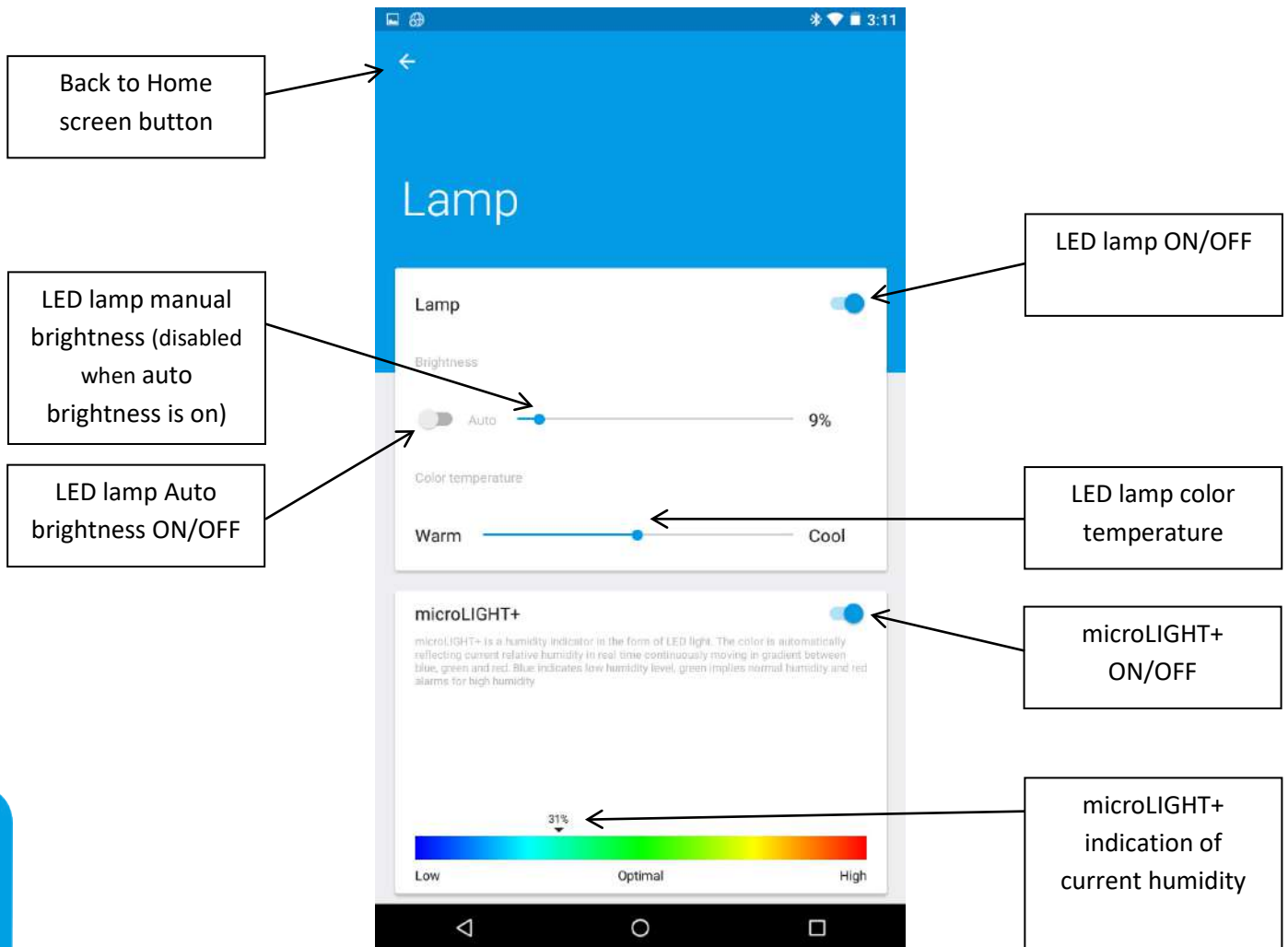

Speaker

Turn the speaker on.



To activate the speaker go to Tablet's Bluetooth settings and turn the Bluetooth on.

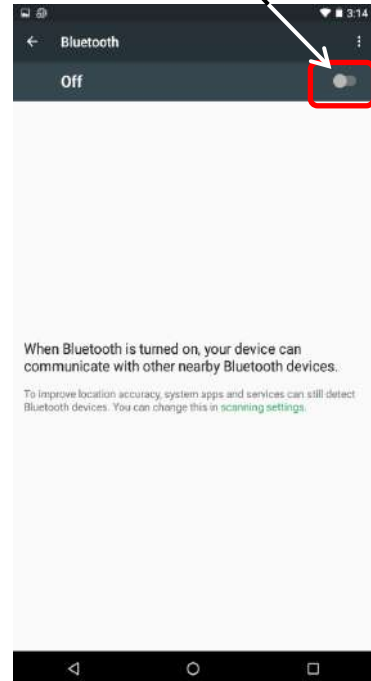

Device will find and pair itself with DRY SIREN speaker (Bluetooth speaker ID, e.g. JPM2021). By DRY SIREN due please mind MASTER and SLAVE units. Master unit is visible for Bluetooth pairing.

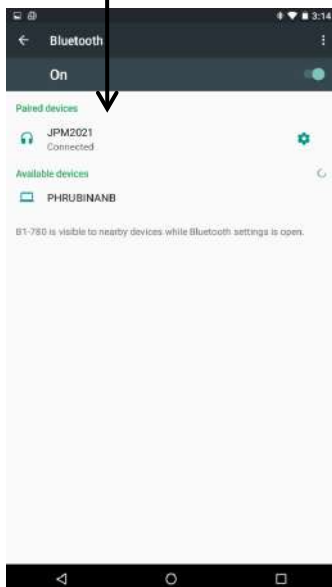

After pairing is successful, go back to application and test sound.

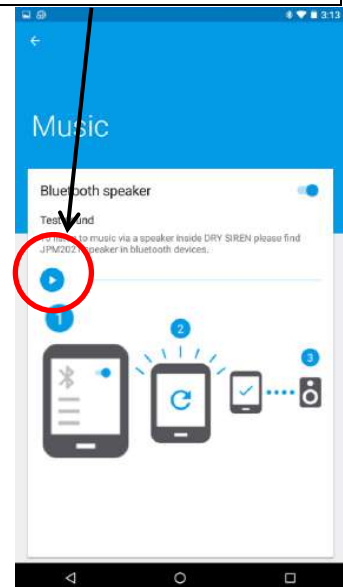

If you hear the sound playing from DRY SIREN, your Bluetooth speaker works properly. In order to play music go to home screen and turn the Music player on. (Music can be played from any source – streaming like youtube, Spotify, memory card, etc.).

13. TECHNICAL DATA

13.1 Technical data table

DATA	UNIT	DRY SIREN MONO
For swimming pools with max. water surface	m ²	60
Extraction rate at 30°C and 60 % RH	l/24hrs	67
Extraction rate at 30°C and 70 % RH	l/24hrs	88
Extraction rate at 30°C and 80 % RH	l/24hrs	104
Operational temperature - standard	°C	5-35
Operational humidity range	% RH	20-100
Air flow	m ³ /h	1000
Noise level (in 1m distance) Ceiling unit	dB (A)	35
Heat output	W	4500
Energy consumption	W	1000
Voltage	V/Hz/f	230/50/1
Operating / Starting current	A	5.2 / 15
Protection	A	16
Conductor	mm ²	CYSY 3C x 2,5
Condensed water pipe	mm	d 18
Dimensions netto (width x height x depth)	mm	Ceiling unit round shape (1210x278), Compressor unit (251x467x404)
Dimensions brutto (width x height x depth)	mm	1400 x 1550 x 850
Weight	kg	Ceiling 53 / Condensing 20
Amount of refrigerant - R 410 A	kg	minimum 1.05kg; 2.088t CO ₂ ekv. = 1.0kg R410A
Max. pressures in the system HP/LP	bar	28,5/8,5
WiFi specification	-	Standard worldwide IEEE802.11b/g/n 2.412~2.484 GHz
Internet connection	-	minimum 40kB/s, 13GB per month data volume
Bluetooth speaker	-	80W stereo, 80Hz-20kHz, 4-8Ω, Bluetooth 3.0 + EDR
LED lamp	-	50W, Warm 3.000K, COLD 5.500K, 4000lm dimnable 0-100% energy class A+

* Manufacturer reserves the right to change above data without notice. For DRY SIREN DUE the data apply in duplicity.

Gas circuit is filled with refrigerant R410A which is two-content refrigerant (R32/R125). Based on ES No. 842/2006 are these contents considered to be a fluorocarbon greenhouse gases. The unit contains fluorocarbon greenhouse gases included in Kyoto Protocol:

R410A with global warming potential (GWP) 1720:
(R-32/125 50/50)
CH F +CF CHF
1.0kg = 2.088t CO₂ ekv.

For exact amount of refrigerant in your device; please turn to serial number sticker (located in the upper right corner of the unit from the back).

13.2 Extraction rate diagram

OUTPUT DIAGRAM OF DEHUMIDIFICATION (DRY SIREN mono)

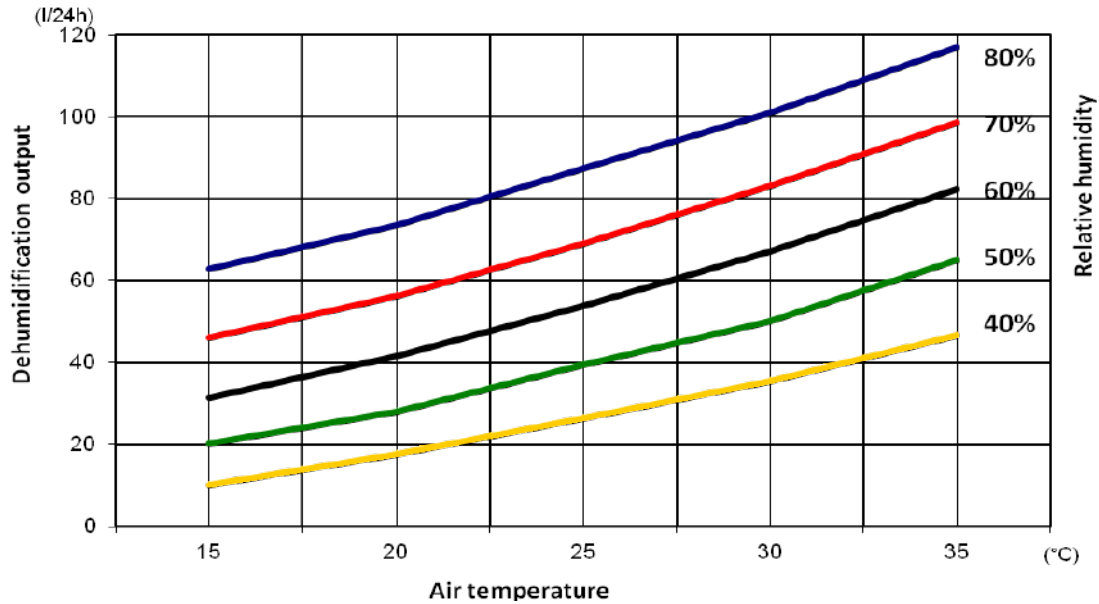

13.3 Wiring diagram

CEILING UNIT SIREN

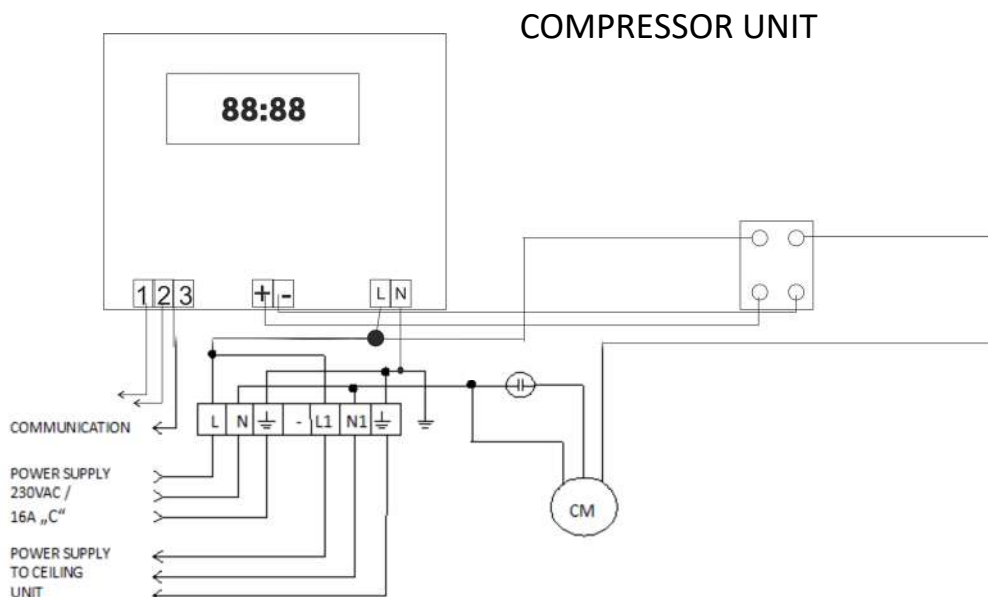
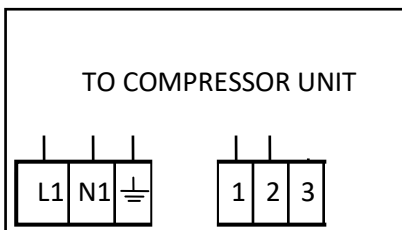

14. HINTS & TIPS

14.1 Error messages

DRY SIREN is equipped with Microwell unique feature microSAFETY+ which enables the manufacturer to see actual technical data of your DRY SIREN in real time. In the case the data indicate technical problem on your DRY SIREN, the manufacturer will advise the distributor/reseller to take appropriate action. Most of error messages are visible only to the manufacturer and also can be accessed via a serial port on compressor unit. This access should be performed by a trained technician with proper equipment. This User's Manual is not designed to deal with serial port access.

Please find here list of error messages visible to end User.

Code	Description	Reason	Status	Solution
C01	Compressor communication error	No feedback from compressor	Error - Dry Siren is malfunctioning. Water collection (dehumidification) is deactivated.	Automatic alarm deactivation after correct value is read or after the sensor is replaced / manual reset
F01	Fan control malfunction	Difference between Fan RPM set point and Fan RPM measurement feedback is greater than defined [%]	Error - Dry Siren is malfunctioning. Water collection (dehumidification) is deactivated.	Manual reset
F02	Exchanger clogged	Temperature difference between compressor (Tk) and condenser (Tkv) is smaller than defined (tempDiffError)	Error - Dry Siren is malfunctioning. Water collection (dehumidification) is deactivated.	Manual reset
F03	Photoconductor malfunction	Photoconductor feedback measurement bad quality	Warning - Dry Siren may not work correctly. Dry Siren continues on operating.	Automatic alarm deactivation after correct value is read or after the sensor is replaced
I01	Defrost not successful	After 3 unsuccessful DEFROST2 cycles	Error - Dry Siren is malfunctioning. Water collection (dehumidification) is deactivated.	Dry Siren will remain 1 hour in Error status (not working). After 1 hours, automatic restart / manual reset.
L01	Refrigerant leak	Compressor temperature above defined maximum (maxCompressorTemperature) - 3rd occurrence within 1 hour	Error - Dry Siren is malfunctioning. Water collection (dehumidification) is deactivated.	Manual reset
L02	High compressor discharge temperature / Refrigerant leak warning	Compressor temperature above defined maximum (maxCompressorTemperature) - 1st and 2nd occurrence within 1 hour	Warning - Dry Siren may not work correctly. Compressor will be turned off for 10min	Compressor temperature back to normal
P01	Condensate pump malfunction	Condensate pump working longer as defined (maxPumpDuration)	Error - Dry Siren is malfunctioning. Water collection (dehumidification) is deactivated.	Automatically if condensate level is low / Manual reset

P02	Condensate level critical	Condensate pump level critical (EXT2)	Error - Dry Siren is malfunctioning. Water collection (dehumidification) is deactivated.	Automatically if condensate level gets low / Manual reset
S01	Humidity sensor malfunction	Insufficient quality from humidity sensor measurement	Warning - Dry Siren may not work correctly. FORCE MODE activation. Compressor will work for 40min (water collection), then 10min pause. This is infinite loop. Bluetooth, microLIGHT and lamp are controllable by app during force mode.	Automatic alarm deactivation after correct value is read or after the sensor is replaced
S02	Condensate level sensor malfunction	Insufficient quality from condensate level sensor measurement	Warning - Dry Siren may not work correctly. Dry Siren continues on operating.	Automatic alarm deactivation after correct value is read or after the sensor is replaced
S03	Difference between humidity sensors too great	If two SHT sensors are connected and the measured value between the two sensors is too big	Warning - Dry Siren may not work correctly. Dry Siren continues on operating.	Change both SHT sensors.
S04	Difference between ambient temperature sensors too great	If two SHT sensors are connected and the measured value between the two sensors is too big	Warning - Dry Siren may not work correctly. Dry Siren continues on operating.	Change both SHT sensors.
S05	Ambient temperature sensor malfunction	Bad quality from ambient temperature sensor measurement	Warning - Dry Siren may not work correctly. Dry Siren continues on operating.	Automatic alarm deactivation after correct value is read or after the sensor is replaced
S06	Compressor temperature sensor malfunction	Insufficient quality from compressor temperature sensor measurement	Error - Dry Siren is malfunctioning. Water collection (dehumidification) is deactivated.	Automatic alarm deactivation after correct value is read or after the sensor is replaced / manual reset
S07	Condenser temperature sensor malfunction	Bad quality from condenser temperature sensor measurement	Warning - Dry Siren may not work correctly. Dry Siren continues on operating.	Automatic alarm deactivation after correct value is read or after the sensor is replaced
S08	Evaporator temperature sensor malfunction	Bad quality from vaporizer temperature sensor measurement	Warning - Dry Siren may not work correctly. FORCE MODE activation. Compressor will work for 40min (water collection), then 10min pause. This is infinite loop. Bluetooth, microLIGHT and lamp are controllable by app during force mode.	Automatic alarm deactivation after correct value is read or after the sensor is replaced
W01	Server connection error	Communication failure with MQTT server	Warning - Dry Siren may not work correctly. Dry Siren continues on	Automatic alarm deactivation after connection or WIFI
W02	Wireless network	WIFI connection to DS not		

	connection error	available	operating (water collection).	is restored.
W03	Can't resolve server IP	Can't resolve server IP		
W04	Route to server not available	Route to server not available		

14.2 Troubleshooting - save time and money

Problem	Cause / Description	Solution
I am unable to pair the DRY SIREN	DRY SIREN is not visible (mobile device cannot locate the DRY SIREN – 'DRY SIREN ID')	Refresh available WIFI networks scan on your tablet until you see DRY SIREN Serial Number = 'SN' from license sticker.
	No internet connection	Check your internet connection. Check your WIFI network password. Check that you have internet connection. Sometimes your WIFI network signals properly but your WIFI router does not have internet access. This may be the case of malfunction of your ISP (Internet Service Provider) service, hardware problem, etc. Some ISPs tend to turn your internet connection off if your bill is overdue. Alternatively restart your WIFI router.
	Incorrect internet password	Check your WIFI network password.
	Incorrect DRY SIREN or Mobile application log-in password	Check the passwords on DRY SIREN LICENCE PLATE.
	Temporary server unavailability	Please wait 5 minutes and repeat the procedure. If you wait longer than 15 minutes and the pairing does not work, contact your distributor or reseller.
	I am unable to control my DRY SIREN.	Internet connection problem / pairing problem.
Failure 'DS UNREACHABLE' shown in application. Once you see this error, please wait 5-10 seconds. Sometimes when response from server due to internet connection is slower, temporarily (max. 10seconds) the DRY		

	SIREN may be 'UNREACHABLE'.	section 11 UNIT TEST – PAIRING.
DRY SIREN does not respond to commands set by application.	You change settings in application but DRY SIREN does not react.	<ol style="list-style-type: none"> 1. Please allow between 1 to 15 seconds to process a command. The time needed to process a command depends on your internet connection. If command is not processed correctly you are advised by a pop-up message 'ERROR IN SENDING COMMAND'. 2. Make sure you are commanding correct DRY SIREN – please turn to DRY SIREN Serial Number shown in application and compare it to the serial number on a Compressor unit. 3. Make sure you are not in DEMO Application. DEMO application by 'TRY ME'. 4. Make sure your DRY SIREN is connected to mains. You can check this by a circuit breaker. Also at ceiling unit you should hear the fan running. Please note that the fan is extremely quiet at normal operations. 5. Alternatively restart your WIFI router.
DRY SIREN does not start although connection seems OK.	The heat pump is not connected to the mains or does not have power supply or circuit breaker is off.	Check the heat pump's connection to the mains and circuit breaker. Check order of the phases.
DRY SIREN does not seem to work. I have condensation on windows, humid air, etc.	Desired humidity equals current.	Everything is OK. It is normal that DRY SIREN does not operate because it has reached requested humidity level. If you feel that the air is humid or you have condensation, decrease the requested level of humidity.
	DRY SIREN does not work for 3 minutes and then it starts.	This is normal. It is time protection for compressor.
	DRY SIREN operates too short	Please allow DRY SIREN to run 24 hours and then check the humidity again.
	DRY SIREN is not connected to the mains or does not have power supply or circuit breaker is off.	Check the DRY SIREN's connection to the mains and circuit breaker.
	DRY SIREN has a technical problem. In such case error message 'Dry Siren is	Call for service.

	malfunctioning.' is shown in application.	
	Refrigerant leak, not enough refrigerant, restriction or other problem on refrigerant connection.	Check the refrigerant connection and amount of refrigerant. Call for service.
DRY SIREN works but the air is humid, there is condensation on windows, etc.	The pool size is too big for DRY SIREN.	Speak with your distributor or reseller and double check the correct capacity for your pool.
	Insufficient air flow. DRY SIREN's evaporator or air flow is blocked by dirt, objects, etc.	Please check the DRY SIREN's ceiling unit positioning for correct positioning 6.2 APPROPRIATE POSITION OF CEILING UNIT.
Other	Other	Please call for service.

14.3 Maintenance

At least once a year it is necessary to have the unit checked to maintain its service and sustain reliability. Following objects/items to be checked:

- Ceiling unit fixation – Visual check - threaded bars and nuts holding OK? No crack/damage/bend?
- Condensate drain – Visual check - does it drain OK? Clean of dust? No waving? No leakage? No water on the stain on the ceiling or the wall?
- Copper pipes – Visual check - connection OK? No leak?

Unit is equipped with 24/7 protection system microSAFETY+. Unless the unit shows error message or unless manufacturer advises your supplier of an error or seeming malfunction, the unit is fully operational and working in order.

14.4 Summer shut-down

Some swimming pool users use to shut the dehumidifier for the summer down. This is mainly due to favorable weather conditions with dry and warm weather. In such case, good air ventilation / natural air exchange does the job of humidity control for few weeks of the year. Although following rapid change in weather (e.g. into rainy days) may result in high humidity in your pool.

In this case please make sure that:

1. Dehumidifier's circuit breaker is off (i.e. dehumidifier does not have any power supply)
2. Dehumidifier is cleaned of dust, fluff or other dirt that may harden / stiffen its structure during the shutdown period making it hard to remove afterwards.

3. Make sure air inlet and outlet are covered properly so no chlorine or other chemicals are not input into dehumidifier body, especially ventilator bearings. Failing to do so may result in bearings corrosion and failure of the dehumidifier.
4. Manufacturer does not suggest any planned shutdown of the system because during shut down period the humidity is not controlled effectively and automatically.

14.5 Super-chlorination cleaning

Although DRY SIREN is constructed from the most durable and chemically resistant materials, chlorine is a very aggressive substance. Typical pool air chlorine content is up to 1.0ppm. DRY SIREN is equipped with special anti-chlorine protections but cannot protect the unit in environment of higher chlorine than 3.0ppm. When cleaning the pool hall premises by super chlorination please note that DRY SIREN must be off as chlorine concentrations go beyond warranty 3ppm up to 24ppm during super chlorination. The unit must be off and ideally covered.

14.6 Start-up during construction

When you start the device at pool which is still under construction, please start the device for a minimum time. Do not run the device longer than few minutes. Dust present in air may be gathered on coils and reduce the water collection capacity. Perform the start-up test and demonstration but keep the unit off and covered until the pool is fully constructed.

14.7 microLIGHT+

DRY SIREN is equipped with Microwell unique system microLIGHT+. This is built into the LED lamp and if activated (mobile application LIGHT settings) microLIGHT+ will signalize the actual level of humidity through color.

BLUE – humidity low

GREEN – humidity OK

YELLOW – humidity is rising above critical level

ORANGE – humidity is rising above critical level

RED – humidity too high

Ideal humidity in pools is between 55% and 65% RH. Humidity above 70% is too high and continuously deteriorates the materials in the pool and creates a favorable environment for bacteria. Humidity below 40% dries mucous tissue and is typically considered 'dry'. With microLIGHT+ you do not need to understand the figures. When there is green you have no problem. Where there is continuous red, you have a problem.

microLIGHT+ will also signalize your humidity is rising. For example if you have your pool covered and humidity OK, you have green light. When you uncover it and start swimming, it is possible that after some time the microLIGHT+ will turn to some gradient of yellow, orange or red. This signalizes that your humidity is rising. Do not be disturbed, this is normal. Once you stop using the pool for the day and cover it, DRY SIREN should dry the air out in maximum few hours (depending on actual sizing of your pool) and the color should go back to normal, i.e. green. If red persists for longer than 1 day, please check the device.

15. WARRANTY

This dehumidifier is subject to a warranty period of 2 years. It may have been prolonged in your country or by your distributor or reseller. Please contact your reseller or distributor in the case a warranty should be claimed for this dehumidifier.

Please note that no claims will be accepted (warranty void) if:

1. The dehumidifier has been used in an incorrect way, not as described in this manual or in contrary to this User's manual or against Safety measures of this User's manual.
2. The dehumidifier is installed in an incorrect way, not as described in this User's manual or in contrary to this User's manual.
3. The dehumidifier was put to operation by an unauthorized person.
4. The air flow through the dehumidifier is out of the defined borders.
5. The unit has been exposed to a mechanical damage / force or any unauthorized action was performed on construction of a unit - welding, brazing or has been mechanically damaged resulting in scratches, blends, compressions, pipe ruptures, etc. No mechanical damage is accepted as warranty claim. Transport damages must be claimed in written with transporting agent delivering the device.
6. Chemical conditions in the pool or pool hall have not been within the defined borders (*please see below table Allowed chemical conditions*).
7. The dehumidifier suffered frost or overheating damage resulting from ambient air temperatures out of Temperature operational range.
8. The electric tension source is insufficient or improper in any other way.



When applying for warranty, please contact your distributor and indicate dehumidifier model and serial number. Please describe the genesis of the failure.

Allowed chemical conditions:

Acidity / pH level:	pH	7,4 +/- 0,4
Total alkalinity, as CaCO ₃	ppm	80-120
Total hardness, as CaCO ₃	ppm	100-300
Total melted dry mass	ppm	max. 3000
Maximal saline content	wt/wt	6%
Free chlorine range	ppm	1,0-3,0
Superchlorination	ppm	max. 30 ppm/max. 24 hours
Bromine	ppm	2-3
Baquacil	ppm	25-50
Ozone	ppm	0,8-1,0
Maximum copper content	ppm	max. 2
Aquamatic single purifier	ppm	max. 2
Tarn clean purifier	ppm	max. 2
Sherwood purifier	ppm	max. 2

Table: Allowed chemical conditions

TRANSPORT INSTRUCTIONS



The compressor unit must be transported in the original packaging only and in a vertical upright position. Make sure that the compressor unit cannot turn over or fall down during transport. Never put the compressor unit aside! It may lead to serious compressor damage, unit's malfunction, damage or failure. This is warranty void.

No mechanical damage is accepted as warranty claim unless a written claim had been made with transporting agent delivering the device. When receiving the product please check whether the package is not damaged. Please make a proper documentation of any damage immediately after delivery and claim all transport damage in written form with the forwarding agent at the delivery.

15.1 INSTALLATION CHECK-LIST AND WARRANTY CARD

FOR THE INSTALLER:

After the installation please go through below check-list. Fill it in, sign, stamp and hand over to customer please.

Ceiling unit fixed and secured with hooks and clips (total 8x)	YES	NO
Eventual disruptions in vapor barrier fixed. Vapor barrier not disrupted.	YES	NO
Condensate drain of ceiling unit installed correctly (max. 20cm upward, then declivity, no waving, no elevation; end by siphon)	YES	NO
Electrical connection done OK	YES	NO
Refrigerant connection done OK	YES	NO
Leak test performed without leakage(s) detected	YES	NO
System vacuuming performed	YES	NO
Connecting refrigerant distance meters	
Final refrigerant chargekg R410A	
Mobile application successfully paired and tested	YES	NO
Bluetooth speaker successfully paired and tested	YES	NO

Date:

Name:.....

Company stamp:..... Signature:.....

Notes:



Notes:

Manufacturer:

MICROWELL, spol. s r.o.
SNP 2018/42, 927 01 Šaľa, Slovakia
tel.: +421/31/7707082
e-mail: microwell@microwell.sk
www.microwell.eu

Made in EU

Distributed by: